



PROFILE OF INNOVATION



Innovative Installation Systems for Tile and Stone

Product Overview

Our Mission

Since the early 1970's, Schluter®-Systems' exclusive purpose has been to develop innovative solutions for tile and stone installations. Our products combine state-of-the-art technology and attention to detail for permanently functional and visually appealing results.

Education and Training

Schluter®-Systems is committed to education and training in industry-approved ceramic tile and natural stone installation methods.

- Registered Continuing Education provider for AIA/CES
- Competent and qualified technical support both in-house and in the field
- Nationwide on-site seminars and training sessions

Customer Service and Technical Support

Schluter®-Systems provides extensive support both in-house and in the field. Call us directly at 1-800-472-4588 (US) or 1-800-667-8746 (Canada) to speak to one of our knowledgeable Customer Support Representatives, refer to our informative literature, or visit our website, www.schluter.com, where you'll find installation instructions and videos, downloadable brochures, product data sheets, a product specifications guide, CAD drawings, reference projects, and more.

CONTENTS



Finishing, edge-protection, & transition profiles for floors



Finishing & edge-protection profiles for walls & countertops

Overview of countertop system components



Stair-nosing profiles



Movement joint & cove-shaped profiles



Schluter®-KERDI-BOARD



Waterproofing, uncoupling, & drainage membranes



Shower system

Overview of shower system components



Finishing profiles, gutters, & accessories for balconies & terraces



Modular screed system for conventional & radiant-heated screeds



Schluter®-Systems floor profiles protect tile edges, create clean transitions to adjacent flooring materials, and provide decorative accents within the tile covering. Schluter® floor profiles, which are available in a variety of shapes, sizes, materials, and finishes, accommodate same-height transitions as well as those between floor coverings of different heights.

Same-height Transitions

Schluter®-SCHIENE

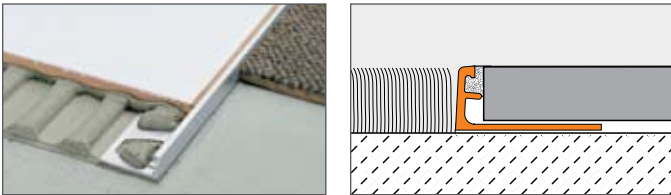

Schluter®-SCHIENE finishes and protects the edges of tiled coverings, as well as other surfacing materials.

Schluter®-DECO

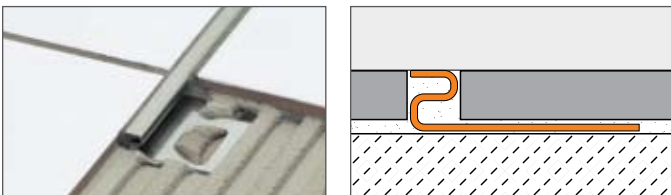

Schluter®-DECO has a 1/4" (6 mm)-wide visible surface for creating decorative joint designs in tiled surfaces or transitions to other surface coverings of the same height.

Schluter®-RENO-T

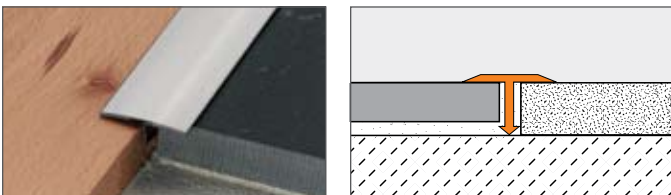

Schluter®-RENO-T is retrofitted to provide a transition between hard surface coverings of the same height.

RADIUS



Schluter®-SCHIENE, Schluter®-DECO, Schluter®-RENO-TK, and Schluter®-JOLLY can be produced with a special perforated anchoring leg to radius the profile.

Sloped Transitions

Schluter®-RENO-TK

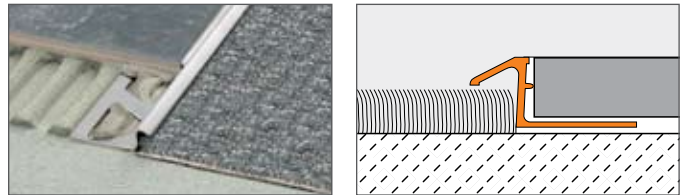

Schluter®-RENO-TK is designed to provide a smooth transition from tile to floor coverings at lower elevations, typically carpet.

Schluter®-RENO-U

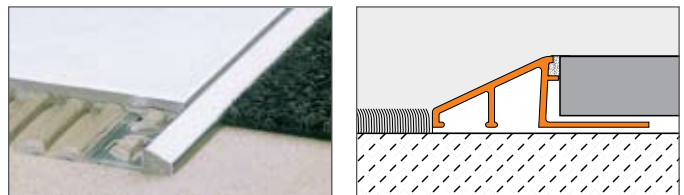

Schluter®-RENO-U is designed to provide a smooth transition from tile to floor coverings at lower elevations, typically VCT or finished concrete.

Schluter®-RENO-V

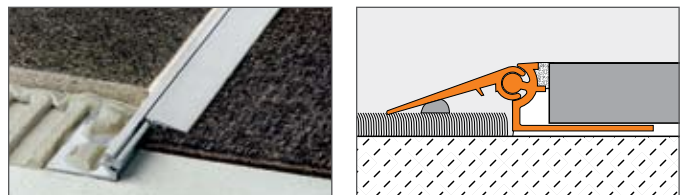

Schluter®-RENO-V has a variable transition leg for smoothly joining floor coverings of different heights.

Schluter®-RENO-RAMP

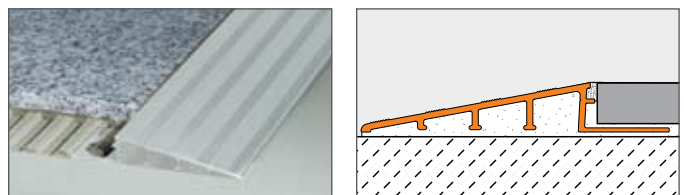

Schluter®-RENO-RAMP is a heavy-duty transition profile that provides a gradual slope between tiled floors and lower adjoining floor surfaces. Ideal for commercial applications where wheel carts are used.



Schluter®-Systems' wall profiles, available in a variety of colors and finishes, provide edge protection and decorative finishing and allow the use of any ceramic or stone tile on walls or countertops, regardless of the availability of trim pieces.

Schluter®-JOLLY



Schluter®-JOLLY finishes and protects outside wall corners and other tiled edges.

Schluter®-RONDEC

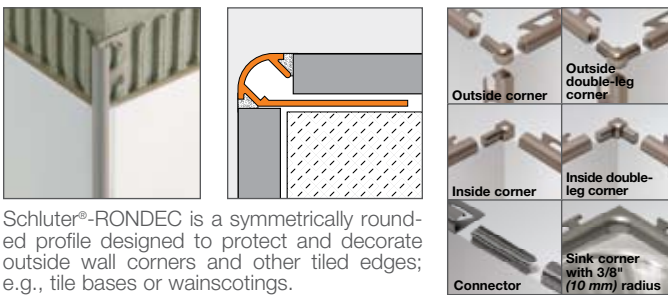

Schluter®-RONDEC is a symmetrically rounded profile designed to protect and decorate outside wall corners and other tiled edges; e.g., tile bases or wainscotings.

Schluter®-RONDEC-DB

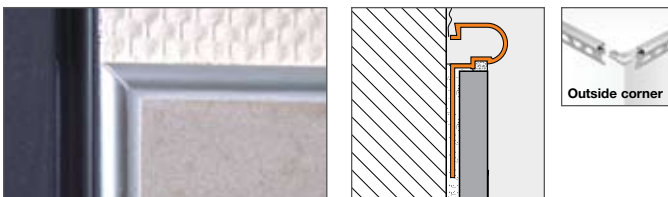

Schluter®-RONDEC-DB is a decorative profile for wall and skirting edges.

Schluter®-RONDEC-STEP

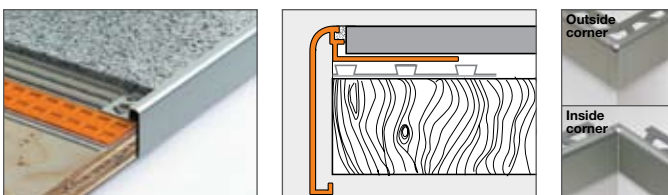

Schluter®-RONDEC-STEP is an edging profile for countertops or stairs that have been fitted with a ceramic or stone tile covering.

Schluter®-QUADEC

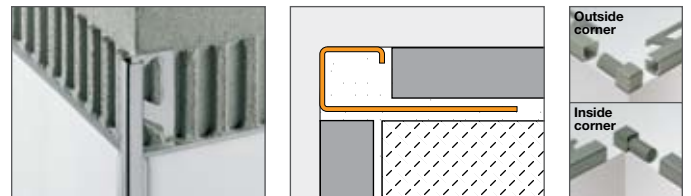

Schluter®-QUADEC is a square profile that protects and decorates outside wall corners and other tiled edges. It may also be used as an accent in tile fields. The universal corner piece is used as an inside or outside corner.

Schluter®-QUADEC-FS

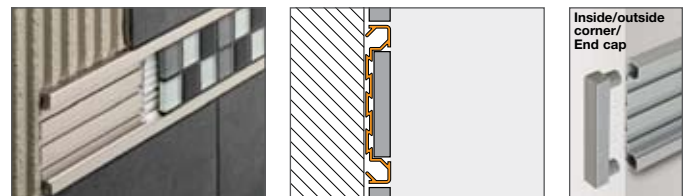

Schluter®-QUADEC-FS is a double-rail profile that features a recessed section with dovetailed grooves to which field or accent tile is bonded. The profile integrates with Schluter®-QUADEC and can be used to produce accents in tile fields on walls, chair rails, and various other decorative applications. The universal corner piece is used as an inside corner, outside corner, or end cap.

Schluter®-DESIGNLINE



Schluter®-DESIGNLINE is a border profile for creating decorative designs in wall coverings.

Schluter®-RONDEC-CT

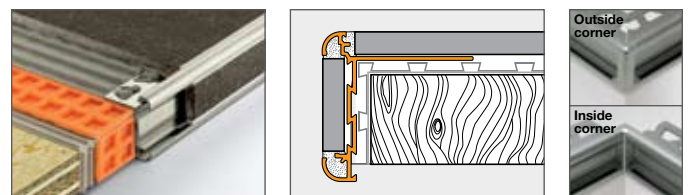

Schluter®-RONDEC-CT is a double-rail edging profile for countertops that have been fitted with a ceramic or dimensional stone tile covering. RONDEC-CT allows for accent or field tile to be bonded to the countertop face.



Schluter®-ECK-E

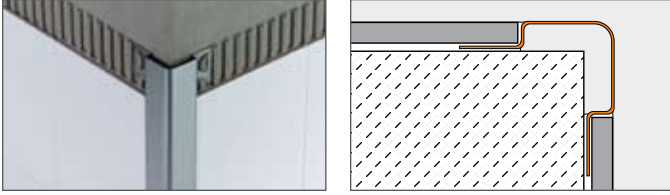

Schluter®-ECK-E is a stainless steel edging profile for outside wall corners on tiled surfaces, offering excellent protection for edges subject to high degrees of wear. The perforated anchoring legs are embedded in the mortar bond coat during tile installation.

Schluter®-ECK-KI

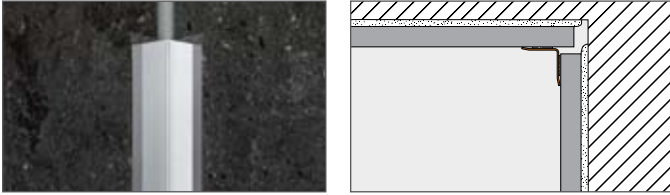

Schluter®-ECK-KI is a stainless steel profile for inside wall corners that produces a clean, decorative finish. ECK-KI is subsequently bonded to the inside corners of existing tile or other wall coverings. As such, the profile can be installed as a repair so that existing, damaged corners do not have to be replaced.

Schluter®-ECK-K

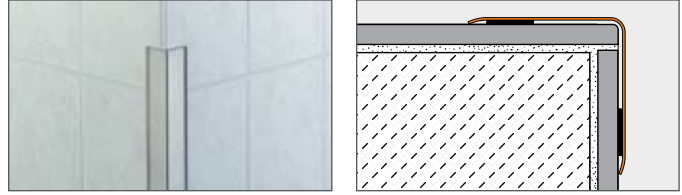

Schluter®-ECK-K is a stainless steel corner profile, subsequently installed to protect the outside corners of tiled walls or other wall coverings.

Schluter®-ECK-KHK

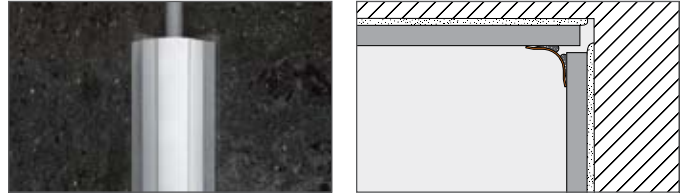

Schluter®-ECK-KHK is a stainless steel profile for inside wall corners that produces a radiused edge for a clean, decorative finish. ECK-KHK provides a $5/16"$ (8 mm) radius to prevent the accumulation of dirt and make cleaning simple. Thus, the profile is especially suited for commercial kitchens, bathrooms, food processing plants or any environment where a sanitary corner is desired.



Schluter®-Countertop System



1 Schluter®-KERDI-BOARD

consists of an extruded polystyrene foam panel with a special reinforcement material on both sides and fleece webbing for effective anchoring to thin-set mortar. It is particularly suitable for building countertops with tile coverings. KERDI-BOARD is dimensionally stable and waterproof and can be adhered directly to base cabinets, thus eliminating the need for labor-intensive preparation. Panels and openings are easily cut with a utility knife.

2 Schluter®-KERDI-BAND

is a waterproofing strip used to seal KERDI-BOARD seams and countertop/backsplash transitions.

3 Schluter®-DILEX-AHK/-EHK/-HKW

are cove-shaped profiles that eliminate caulk joints for maintenance-free countertop/backsplash transitions. The cove shape allows for easy cleaning and will not trap debris, making the profiles ideal for areas where food products are handled and strict hygiene is essential. Matching inside and outside corners, connectors, and end caps are available. Schluter®-DILEX-EKE can be used as an alternative to the cove-shaped profiles listed above.

4 Schluter®-RONDEC-CT

is a sink rail profile for countertops that have been fitted with a ceramic or stone tile covering. The face of the profile features a recessed section with dovetailed grooves to which field or accent tile is bonded, thus eliminating the need for ceramic trim. Matching inside and outside corners (90° and 135°) are available. Schluter®-RONDEC-STEP can be used as an alternative to Schluter®-RONDEC-CT.

5 Schluter®-RONDEC

is a finishing and edge-protection profile which can be used to produce tiled-under sinks and to finish the edge of your backsplash. A tiled-under sink and tiled backsplash create a neat appearance and make the countertop easy to clean since there is no lip to trap debris. Matching corners are available including special sink corners.



Schluter®-Systems stair nosings protect tile edges and improve safety on tiled stairways by providing a slip-resistant wear surface and increased visibility.

Schluter®-RONDEC-STEP

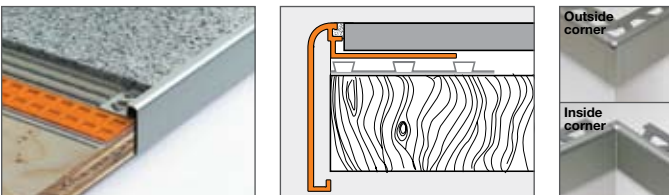

Schluter®-RONDEC-STEP is an edging profile for countertops or stairs that have been fitted with a ceramic or stone tile covering.

Schluter®-TREP-S/-SE/-B

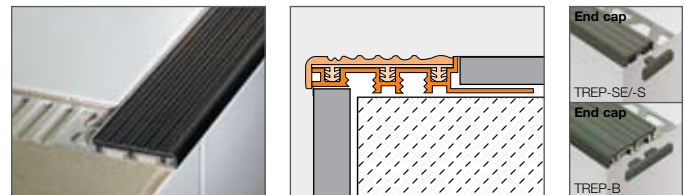

Schluter®-TREP-S/-SE/-B feature support sections of aluminum (-S/-B) or stainless steel (-SE) and replaceable, slip-resistant thermoplastic rubber treads. The profiles protect tiled stair edges and provide an easily visible, slip-resistant wear surface for durable, safe, and visually appealing stair-nosing design in commercial applications.

Schluter®-TREP-FL

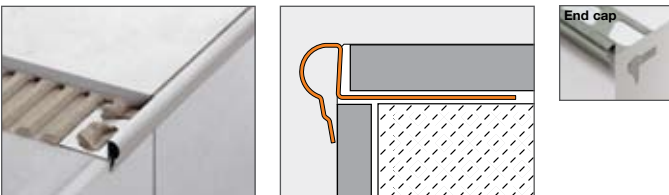

Schluter®-TREP-FL is a stainless steel stair-nosing profile with a decorative protruding rounded edge used to finish and protect tiled stair edges.

Schluter®-TREP-T/-MT/-TL

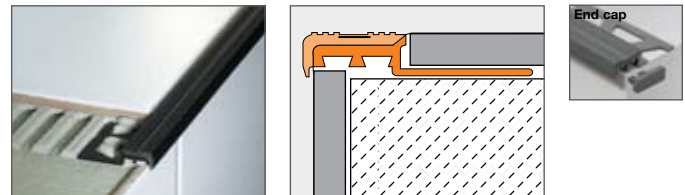

Schluter®-TREP-T/-MT/-TL are PVC profiles that protect tiled stair edges and provide an easily visible, slip-resistant wear surface for durable, safe, and visually appealing stair nosings in residential applications.

Schluter®-TREP-E

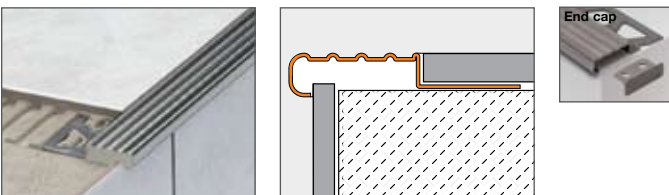

Schluter®-TREP-E is a stainless steel stair-nosing profile that protects tiled stair edges and provides an easily visible, slip-resistant wear surface for durable, safe, and visually appealing stair nosings in commercial applications.

Schluter®-TREP-EK

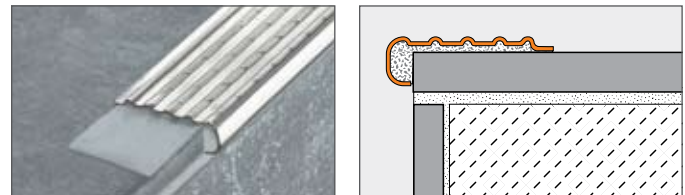

Schluter®-TREP-EK is a stainless steel stair-nosing profile with a slip-resistant wear surface for enhancing the safety and visual appeal of tiled stair edges. TREP-EK adheres to the surface of existing ceramic tile or natural stone stair treads.

Schluter®-TREP-G

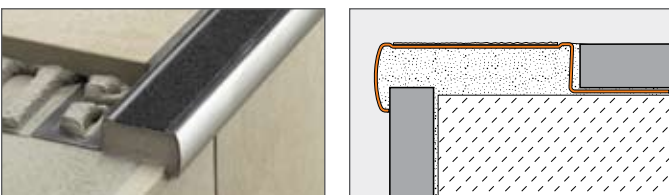

Schluter®-TREP-G is a stainless steel stair-nosing profile with a slip-resistant wear surface for enhancing the safety and visual appeal of tiled stair edges. The surface features a self-adhesive, non-slip tread with an embedded mineral grain coating, which is available in a variety of colors and can be replaced in case of damage or wear.

Schluter®-TREP-GK

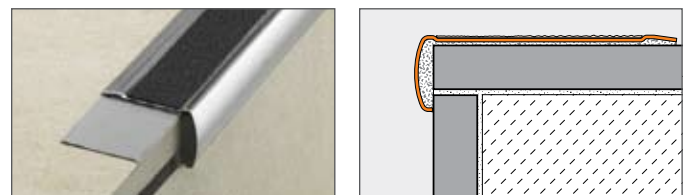

Schluter®-TREP-GK is a stainless steel stair-nosing profile with a slip-resistant wear surface for enhancing the safety and visual appeal of tiled stair edges. TREP-GK adheres to the surface of existing ceramic tile or natural stone stair treads.



An installed ceramic tile floor is rigid by nature and similar in physical characteristics to a large sheet of glass. This is particularly true with today's large-format tiles and narrow joint design. Movement joints must be incorporated within large surfaces, at doorsills, and at transitions to walls and other restraining structures to allow for movement and thus reduce stress buildup that could otherwise cause cracking and loosening of the tile covering. Schluter®-Systems' prefabricated movement joint profiles eliminate the need for caulking, protect tile edges, and prevent sound bridges and surface water penetration, resulting in a permanent, maintenance-free installation. The Schluter®-DILEX family of prefabricated movement joints includes a variety of shapes, sizes, and materials to suit different applications.

Surface Joint Profiles

Schluter®-DILEX-EZ 6 + 9

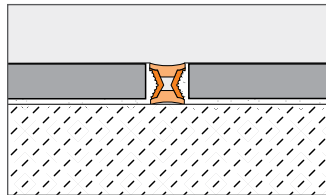

Schluter®-DILEX-EZ 6 and 9 combine decorative design and stress relief. The profile features two usable surfaces in different colors. The sidewalls are made of rigid PVC; the movement zones are made of soft PVC.

Schluter®-DILEX-BWS

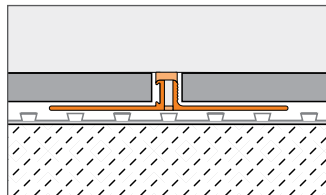

Schluter®-DILEX-BWS is a movement joint profile that features anchoring legs made of rigid, recycled PVC and a movement zone made of soft CPE that creates the 3/16" (5 mm)-wide visible surface.

Schluter®-DILEX-BWB

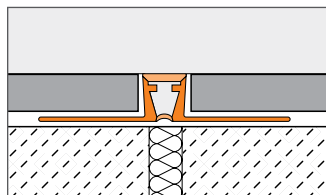

Schluter®-DILEX-BWB is a movement joint profile that features anchoring legs made of rigid, recycled PVC and a movement zone made of soft CPE that creates the 3/8" (10 mm)-wide visible surface.

Schluter®-DILEX-AKWS

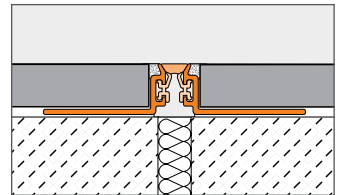

Schluter®-DILEX-AKWS is a movement joint profile that features anchoring legs made of aluminum and a movement zone made of soft PVC that creates the 1/4" (6 mm)-wide visible surface.

Schluter®-DILEX-KSN

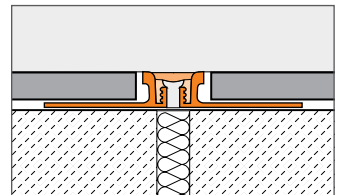

Schluter®-DILEX-KSN is a movement joint profile that provides edge protection for tile and stone coverings exposed to heavy mechanical stresses. The profile's anchoring legs, made of brass, aluminum, or stainless steel, are connected to a replaceable movement zone made of soft synthetic rubber.

Schluter®-DILEX-EDP

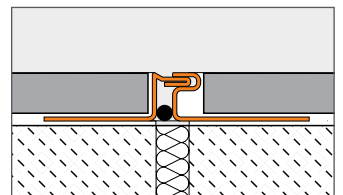

Schluter®-DILEX-EDP is a stainless steel movement joint profile that allows horizontal movement via a tongue-and-groove connection. DILEX-EDP is particularly suited for floors subject to heavy mechanical stresses and chemical exposure.



Expansion Joint Profiles

Schluter®-DILEX-KSBT

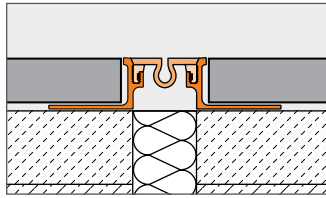

Schluter®-DILEX-KSBT is an expansion joint profile with anchoring legs made of brass, aluminum, or stainless steel, which are connected to a replaceable 3/4" (20 mm) or 1-3/16" (30 mm)-wide movement zone made of soft synthetic rubber that forms the visible surface.

Schluter®-DILEX-BT

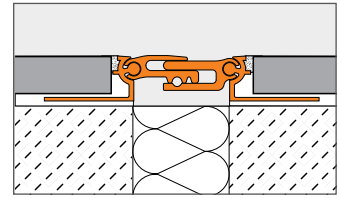

Schluter®-DILEX-BT is an expansion joint profile made of anodized aluminum or brass, with opposing support profiles that connect to a sliding telescopic center section. This allows for absorption of three-dimensional movement.

Perimeter Joint Profiles

Schluter®-DILEX-AS

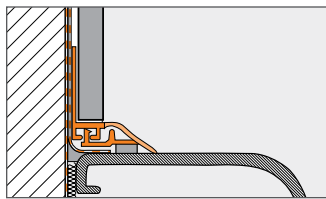

Schluter®-DILEX-AS is a joining profile for creating flexible joints to fixed building elements such as shower trays, bathtubs, and door and window frames. Matching inside corners and end caps are available.

Schluter®-DILEX-KSA

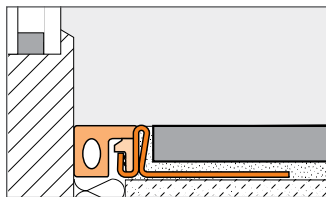

Schluter®-DILEX-KSA is a perimeter movement joint profile with edge protection. The profile's anchoring leg, made of aluminum or stainless steel, is connected to a 3/8" (10 mm)-wide replaceable movement zone made of soft PVC. The profile is used for creating transitions between tile or stone coverings and fixed building elements, such as shower trays, bathtubs, and door and window frames.

Schluter®-DILEX-BWA

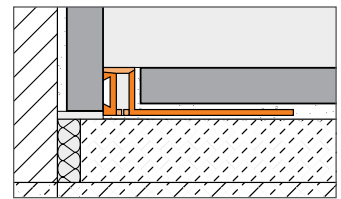

Schluter®-DILEX-BWA is a perimeter movement joint profile with a recycled rigid PVC anchoring leg and dovetailed channel that can be bonded to fixed building elements such as shower trays, bathtubs, countertops, and door and window frames. The soft CPE movement zone creates the 3/16" (5 mm)-wide visible surface.



Cove-shaped Profiles

Schluter®-DILEX-EKE

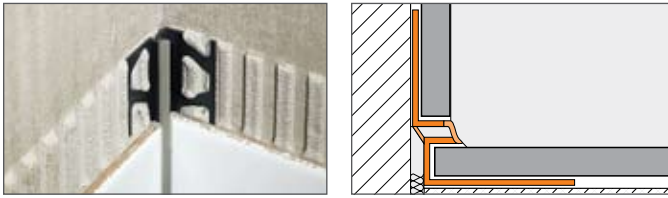

Schluter®-DILEX-EKE is a corner movement profile that effectively absorbs movement at inside wall corners and at floor/wall transitions in applications where no large movement is expected. The profile features recycled rigid PVC anchoring legs and a 3/16" (5 mm)-wide soft CPE movement zone that forms the visible surface and creates a discrete joint.

Schluter®-DILEX-PHK

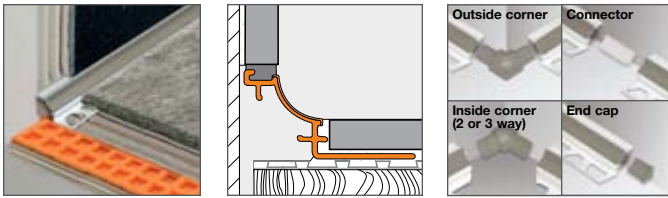

Schluter®-DILEX-PHK is a PVC, cove-shaped profile for inside wall corners, countertop/backsplash transitions and floor/wall transitions in applications where limited movement is expected. DILEX-PHK provides a 3/8" (10 mm) radius to prevent the accumulation of dirt and makes cleaning simple.

Schluter®-DILEX-EHK

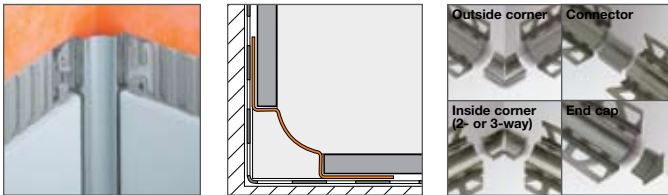

Schluter®-DILEX-EHK is a stainless steel cove-shaped profile for inside wall corners or floor/wall transitions where limited movement is expected, including environments with strict hygienic requirements and/or possible chemical exposure (e.g., hospitals, industrial kitchens, clean rooms, washrooms, and food-processing plants).

Schluter®-DILEX-HKW

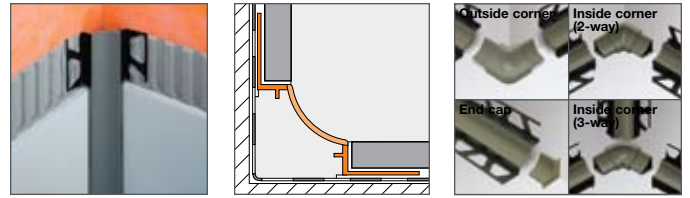

Schluter®-DILEX-HKW is a cove-shaped profile for inside wall corners and floor/wall transitions where limited movement is expected, including environments with strict hygienic requirements. The profile's anchoring legs are made of recycled rigid PVC; the cove section is made of colored PVC.

Schluter®-DILEX-AHK

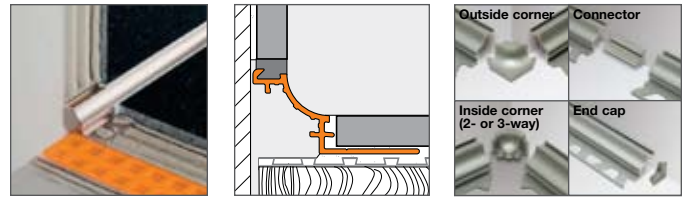

Schluter®-DILEX-AHK is an anodized aluminum, cove-shaped profile for inside wall corners, countertop/backsplash transitions, and floor/wall transitions where limited movement is expected, including environments with strict hygienic requirements. The profile features a single anchoring leg for ease of installation.



With the available panel thicknesses of 3/16", 3/8", 1/2", 3/4", 1", 1-1/2", and 2" (5, 9, 12.5, 19, 25, 38, and 50 mm), KERDI-BOARD allows the installer to prepare and create a broad range of substrates and building elements for the installation of ceramic and natural stone tile that are flat, level, plumb, square, and dimensionally stable. With suitable preparation of the abutting seams and joint areas, the panel may be used for bonded waterproofing assemblies. The boards are simply cut to size with a utility knife. The gridlines, which are printed on the surface, are helpful for neat and quick cuts and installation.

Schluter®-KERDI-BOARD

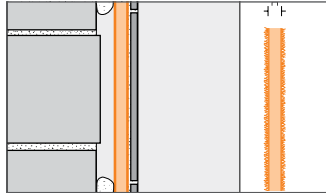

Schluter®-KERDI-BOARD is a multifunctional tile substrate and building panel, which can also be used for creating bonded waterproofing assemblies with tile coverings. It consists of an extruded polystyrene foam panel, with a special reinforcement material on both sides and fleece webbing for effective anchoring in thin-set mortar.

Schluter®-KERDI-BOARD-V

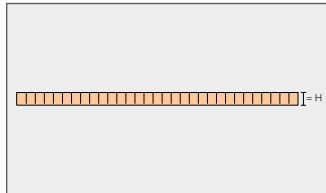
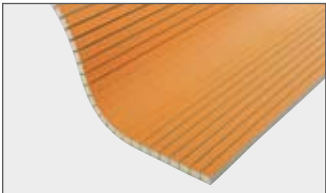

Schluter®-KERDI-BOARD-V is a vertically grooved substrate and building panel for creating curved elements.

Schluter®-KERDI-BOARD-E

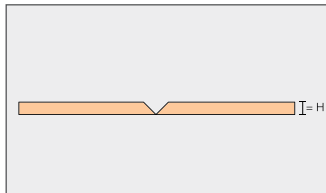
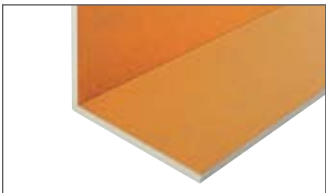

Schluter®-KERDI-BOARD-E is an L-shaped panel used to create corners and pipe or column coverings.

Schluter®-KERDI-BOARD-U

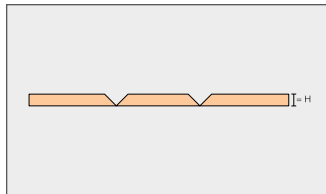
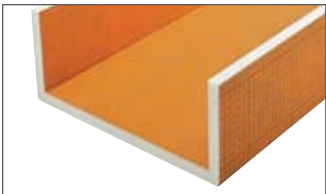

Schluter®-KERDI-BOARD-U is a U-shaped panel used to create pipe or column coverings.

Schluter®-KERDI-BOARD-ZC/-ZA



ZC



ZA

Schluter®-KERDI-BOARD-ZC/-ZA are brushed stainless steel, U-shaped profiles with one or two perforated anchoring legs. They are used to finish the edges of countertops, vanities, and similar structures.

Schluter®-KERDI-BOARD-ZB

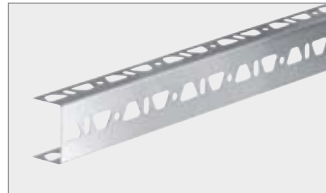

Schluter®-KERDI-BOARD-ZB is a stainless steel, U-shaped profile with three-sided perforation. It is used to fasten and stabilize partition walls and other structures made of KERDI-BOARD panels.

Schluter®-KERDI-BOARD-ZSD



Schluter®-KERDI-BOARD-ZSD are anchors used to provide additional mechanical attachment of KERDI-BOARD when the bond between the thin-set mortar and the substrate is questionable.

Schluter®-KERDI-BOARD-ZS/-ZT

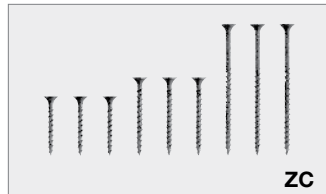

ZC

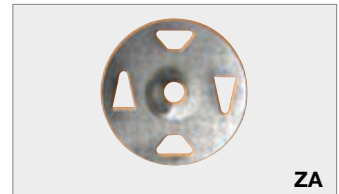

ZA

Schluter®-KERDI-BOARD-ZS are screws used to fasten KERDI-BOARD to stud framing with the corresponding Schluter®-KERDI-BOARD-ZT washers.



Ceramic and stone tiles are durable, easy to maintain, and hygienic, representing the ideal surface coverings. However, today's light-weight construction methods can make the installation of hard surface coverings particularly challenging. In order to protect the integrity of the tile assembly, an underlayment that performs multiple functions is required.



Uncoupling

Tile has been successfully installed for thousands of years by incorporating an uncoupling layer, or forgiving shear interface, within the tile assembly. Schluter®-DITRA provides uncoupling through its open rib structure, which allows for in-plane movement that effectively neutralizes the differential movement stresses between the substrate and the tile, thus eliminating the major cause of cracking and delaminating of the tiled surface.

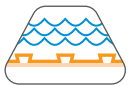

Waterproofing

Schluter®-DITRA provides reliable waterproofing in interior and exterior applications. Its polyethylene composition protects the substrate from moisture penetration, which is particularly important in today's building environment where most substrates are moisture-sensitive.

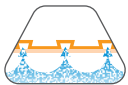

Vapor Management

The distinguishing feature of Schluter®-DITRA is the existence of free space created by the configured channels on the underside of the matting. The free space provides a route for excess moisture and vapor to escape from the substrate that could otherwise cause damage to the tile layer above. Thus, DITRA effectively manages moisture beneath the tile covering.



Support/ Load Distribution

When placed on a solid foundation, columns or pillars can support tremendous loads. The same physical principle applies to Schluter®-DITRA installations. Column-like mortar structures are formed in the cutback cavities of the matting. Loads are transferred from the tile covering through these column-like mortar structures to the substrate. Since DITRA is virtually incompressible within the tile assembly, the advantages of uncoupling are achieved without sacrificing point load distribution capabilities.

Schluter®-DITRA and **DITRA-XL** are polyethylene membranes with a grid structure of square cutback cavities and an anchoring fleece laminated to the underside. In conjunction with tiled coverings, DITRA and DITRA-XL form an uncoupling, waterproofing, and vapor management layer, while providing support/load distribution. The combination of these four essential functions allows for successful tile installations over a wide range of substrates, including plywood/OSB, concrete, gypsum, heated floors, etc.

Schluter®-DITRA

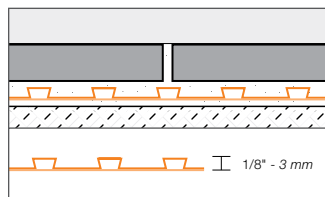

Schluter®-DITRA is 1/8" (3 mm) thick, which minimizes tile assembly thickness and reduces transitions to lower surface coverings (e.g., carpet, engineered wood, and vinyl). DITRA allows for ceramic tile application over single layer plywood or OSB subfloors on joists spaced up to 19.2" (488 mm) o.c.

Schluter®-DITRA-XL

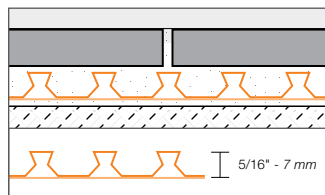
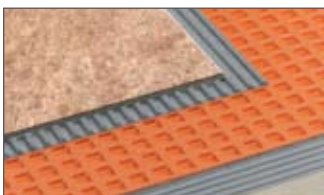

Schluter®-DITRA-XL is 5/16" (7 mm) thick, which permits even transitions between tile and 3/4"-thick hardwood flooring. DITRA-XL allows for ceramic tile application over single layer plywood/OSB subfloors on joists spaced up to 24" (610 mm) o.c.

Schluter®-DITRA Installation Handbook

A comprehensive Installation Handbook, which includes 16 separate installation details, movement joint guidelines, our no-nonsense 5-year warranty, and more. The Handbook is available at www.schluter.com or by calling Customer Service at 1-800-472-4588 (USA) or 1-800-667-8746 (Canada).





Schluter®-Systems provides an integrated family of products in which the individual components collectively form a bonded watertight assembly. The Schluter®-Shower System, which eliminates the risk of failures due to water and vapor penetration, dramatically reduces total installation time and is maintenance-free.

Schluter®-KERDI-DRAIN

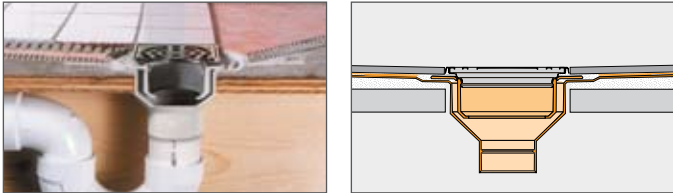

Schluter®-KERDI-DRAIN is a floor drain with a sloped, integrated bonding flange, which allows a secure connection to Schluter®-KERDI or other bonded waterproofing membranes at the top of the assembly. The grate assembly allows for lateral and tilt adjustment and accommodates many tile thicknesses: 1/4" to 1-1/4" (6 - 32 mm). The KERDI-DRAIN bonding flange is available in ABS, PVC, and stainless steel.

The 4" grate is available in stainless steel, oil-rubbed bronze stainless steel or anodized aluminum in 3 different finishes:



The 6" grate is available in a round version and a square version and is used when a higher flow rate is required.



Schluter®-KERDI-DRAIN Adaptor Kits

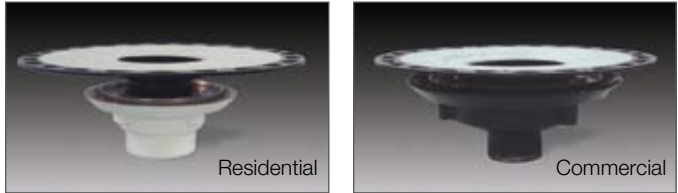

Schluter®-KERDI-DRAIN ADAPTOR KITS are used to convert traditional clamping ring drains to integrated bonding flange drains when removal of the clamping ring drain is not practical. A stainless steel adaptor ring with an overmolded rubber gasket replaces the clamping ring and is sealed to the existing drain body using Schluter®-KERDI-FIX. The bonding flange then slides into the adaptor ring and seals against the rubber gasket. Commercial drain adaptor kits are available with a stainless steel bonding flange or an ABS bonding flange.



Schluter®-KERDI-SHOWER-ST/-SC/-SR/-SB



Schluter®-KERDI-SHOWER-ST is a sloped shower tray made of light-weight, expanded polystyrene for constructing mortar-free shower receptors. The tray is designed to integrate with the KERDI-SHOWER-SC prefabricated curb or KERDI-SHOWER-SR access ramp, as well as the KERDI-SHOWER-SB bench, KERDI-DRAIN and KERDI waterproofing membrane. The prefabricated tray is available in the following sizes:

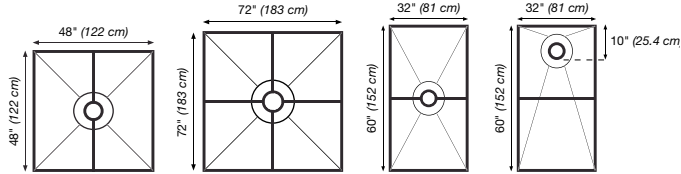

The prefabricated benches are available in the following sizes:

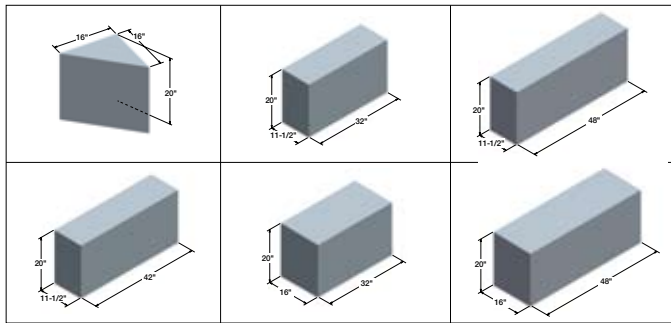

Schluter®-KERDI-SHOWER-KIT



Schluter®-KERDI-SHOWER-KIT is an all-inclusive package containing each of the integrated components required to create a maintenance-free, watertight shower assembly without a mortar bed.

Schluter®-KERDI-SHOWER-KIT includes:

- 1 KERDI-SHOWER-ST – Prefabricated, sloped tray
- 2 KERDI-SHOWER-SC – Prefabricated curb
- 3 KERDI – Waterproofing membrane
- 4 KERDI-BAND – Waterproofing strip
- 5 KERDI-DRAIN – Drain, with integrated bonding flange
- 6 KERDI-KERECK-F – Pre-formed waterproofing corners
- 7 KERDI-SEAL-PS – Pipe seal
- 8 KERDI-SEAL-MV – Mixing valve seal

Schluter®-KERDI



Schluter®-KERDI is a pliable sheet-applied polyethylene waterproofing membrane and vapor retarder that guarantees uniform thickness. It is covered on both sides with a fleece webbing to anchor the membrane in thin-set mortar. KERDI is suitable for waterproofing in conjunction with tiled surfaces on walls and floors.



Schluter®-KERDI-BAND is a waterproofing strip used to seal butt joints and floor/wall connections with the Schluter®-KERDI membrane.

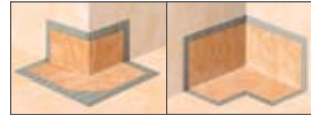

Schluter®-KERDI-KERECK-F are pre-formed, seamless inside and outside corners for Schluter®-KERDI.

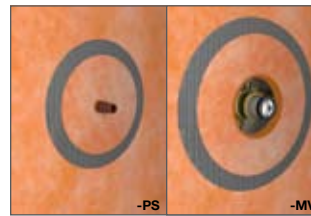

Schluter®-KERDI-SEAL-PS and -MV prefabricated seals are sections of Schluter®-KERDI with overmolded rubber gaskets that are used to seal pipe protrusions through the KERDI waterproofing membrane and protect moisture-sensitive backings at the mixing valve.



Schluter®-KERDI-TROWEL features a 1/8" x 1/8" (3 mm x 3 mm) square-notched design. It is used to install Schluter®-KERDI waterproofing membranes.



Schluter®-KERDI-FIX is a sealing and bonding compound with a silane-modified polymer base which is used to seal penetrations through the Schluter®-KERDI waterproofing membrane and bond the KERDI to the stainless steel version of the KERDI-DRAIN.

- 1 **Schluter®-KERDI-SHOWER-ST/-SC**
are prefabricated shower substrates that provide an alternative to bases constructed of mortar. The KERDI-SHOWER-ST tray is sloped and specifically designed to accept the KERDI-DRAIN. The KERDI-SHOWER-SC curb can be used with the KERDI-SHOWER-ST tray or mortar applications.
- 2 **Schluter®-KERDI-DRAIN**
is a floor drain assembly designed with a sloped, integrated bonding flange to provide a secure connection to KERDI and other bonded waterproof membranes at the top of the assembly.
- 3 **Schluter®-KERDI**
is a pliable sheet-applied polyethylene waterproofing membrane and vapor retarder that guarantees uniform thickness. It is covered on both sides with a fleece webbing to anchor the membrane in thin-set mortar.
- 4 **Schluter®-KERDI-BAND**
is a waterproofing strip to seal butt joints and floor/wall connections with the Schluter®-KERDI membrane.
- 5 **Schluter®-KERDI-KERECK-F**
are pre-formed, seamless, inside and outside corners.
- 6 **Schluter®-KERDI-SEAL**
Schluter®-KERDI-SEAL-PS and -MV prefabricated seals are sections of the Schluter®-KERDI waterproofing membrane with overmolded rubber gaskets that are used to seal pipe protrusions through the KERDI waterproofing membrane and protect moisture-sensitive solid backing panels at the mixing valve.
- 7 **Schluter®-DILEX-AHK/-EHK/-HKW**
are cove-shaped profiles for inside wall corners and floor/wall transitions that eliminate the need for caulking, thus creating hygienic, maintenance-free transitions. Matching inside and outside corners, connectors, and end caps are available. Schluter®-DILEX-EKE can be used as an alternative to the cove-shaped profiles listed above. (See cove-shaped profiles on page 11)





Proper water management at the perimeter is crucial to the success of exterior installations. Schluter®-Systems offers complete assemblies for balconies and terraces, including a gutter system and edging profiles, which provide a neat appearance as well as edge protection.

Membranes

Schluter®-TROBA

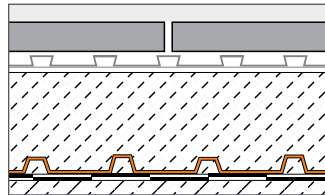

Schluter®-TROBA is a reliable and durable sub-surface drainage system for use over horizontal waterproofing layers. It consists of a pressure-stable, polyethylene sheet with perforated studs, which enable the water to flow freely to the sloped waterproofing layer and on to the designated drainage exit.

Schluter®-KERDI-FIX



Schluter®-KERDI-FIX is a single-component sealing and bonding compound with a silane-modified polymer base.

Schluter®-TROBA-PLUS

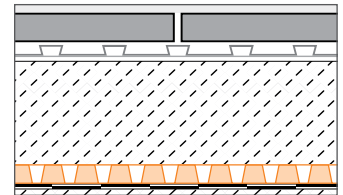
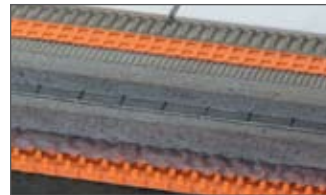

Schluter®-TROBA-PLUS is a durable sub-surface drainage system that permits water to drain off freely and reliably. The closely positioned, cone-shaped studs are covered by a water permeable filter fabric. They serve to support the floor covering over the entire surface, thus creating a continuous drainage area above the waterproofing layer.

Support profile

Schluter®-BARA-ESOT

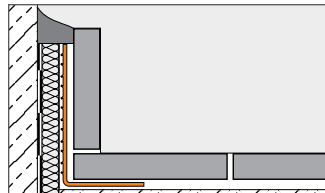

Schluter®-BARA-ESOT is a support profile made of stainless steel for use in applications where no load-bearing substrate is available to support the tile base.



Gutter and balcony profiles

Schluter®-BARA-RW

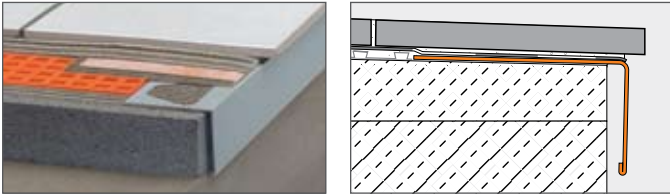

Schluter®-BARA-RW is an angled profile made of stainless steel or color-coated aluminum for finishing the exposed perimeters of balconies and terraces.

Schluter®-BARA-RWL

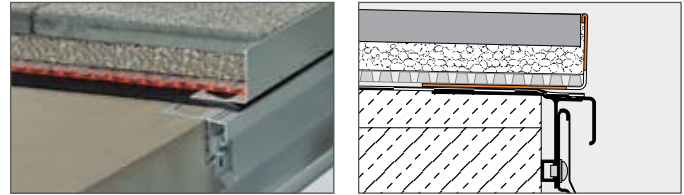

Schluter®-BARA-RWL is a stainless steel or color-coated aluminum edging profile with drainage holes for the perimeters of balconies and terraces. The profile is particularly suitable for loose-laid pavers set on gravel or stilted assemblies above a waterproofing layer and drainage layer.

Schluter®-BARA-RK

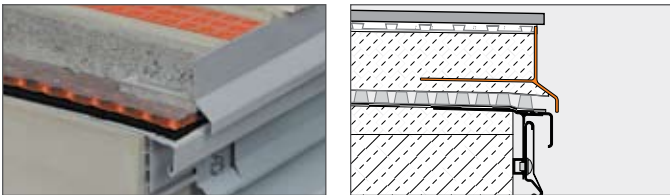

Schluter®-BARA-RK is a T-shaped balcony edging profile made of color-coated aluminum that conceals and protects the mortar bed. The protruding drip lip covers the exposed edge of the Schluter®-TROBA-/TROBA-PLUS sub-surface drainage system.

Schluter®-BARA-RAK

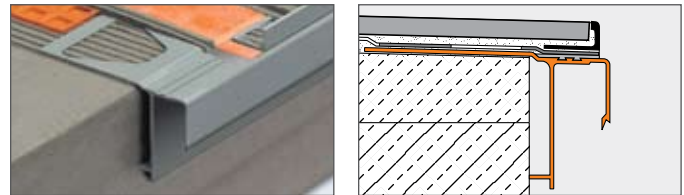

Schluter®-BARA-RAK is a color-coated aluminum edging profile with a drip lip for application to a sloped screed. The profile features a recessed section to accept the installation of Schluter®-SCHIENE as edge protection for the tile covering.

Schluter®-BARA-RTK

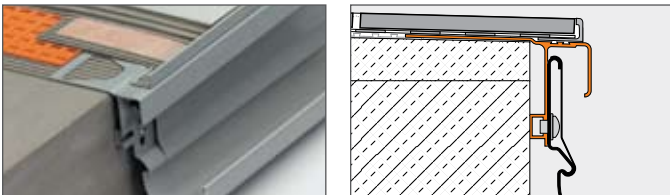

Schluter®-BARA-RTK is a color-coated aluminum edging profile with a drip lip for application to a sloped screed. The profile is equipped with an attachment for fastening the Schluter®-BARIN gutter system and features a recessed section to accept the installation of Schluter®-SCHIENE as edge protection for the tile covering.

Schluter®-BARA-RTP

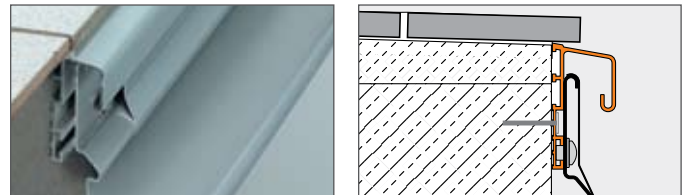

Schluter®-BARA-RTP is an edging profile made of color-coated aluminum, which is used for attaching the Schluter®-BARIN gutter system. The profile is retrofitted to the exposed edges of existing balconies and terraces.

Schluter®-BARIN

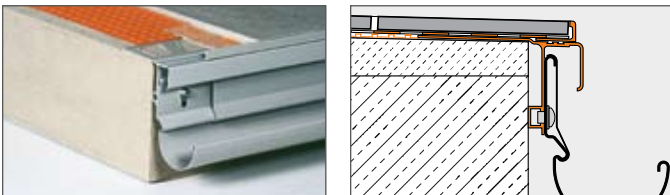

Schluter®-BARIN is a gutter system for the drainage of balconies and terraces, which can be attached to various Schluter®-BARA edging profiles. Schluter®-BARIN gutter components, including covers, end caps, corners, and connectors, are made of color-coated aluminum. Additional accessories (e.g., couplings, down pipes, and spouts) are available.



Schluter®-BEKOTEC is a lightweight modular screed system, which produces permanent flooring assemblies that are free from internal stresses and which can be installed with or without integrated radiant heating tubes. The BEKOTEC modular screed system allows the installation of continuous screed surfaces without any control joints or reinforcing wire.

Radiant Heat

Advantages

- Integrated thermal break and thermal mass
- Easy installation of radiant heating tubes
- Energy efficient
- Reaches target temperature quicker than conventional systems
- Suitable for virtually any surface coverings used in radiant heat applications

Radiant Heat Function



A flooring assembly equipped with the Schluter®-BEKOTEC Modular Screed System reacts faster to changes in temperature than conventional radiant heat systems, since a substantially lower mass is being heated or cooled. The cutback design ensures that heating tubes from 3/8" to 5/8" (10 to 16 mm) outside diameter (O.D.) are securely held without clamps in straight runs. Clamps may be necessary where the tubes are turned into a relatively tight radius.

Modular Screed

Advantages

- No build-up of internal stresses
- No control joints or reinforcing wire
- 20% less weight than conventional 1-1/4" screed (50% less than 2" screed)
- Fast construction

Modular Screed Principle

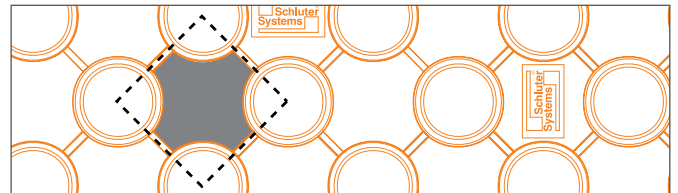

The screed surface is divided into 4-1/4" (108 mm) modules. Shrinkage during the curing process is limited to each module due to the formation of microfine cracks, which develop between the studs in the screed panel, thus controlling deformations such as curling and continuous cracks. Therefore, no control joints or reinforcing wire are required in the screed.

Schluter®-BEKOTEC

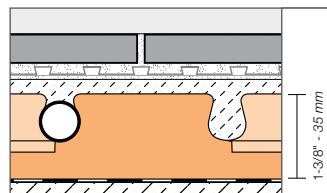

Schluter®-BEKOTEC-F

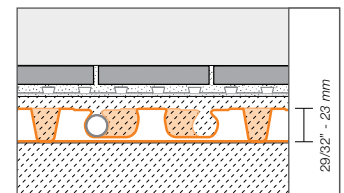
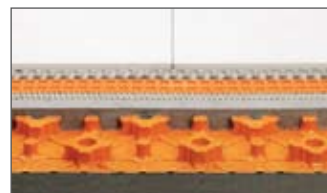

Schluter®-BEKOTEC and Schluter®-BEKOTEC-F are lightweight modular screed systems, which produce permanent flooring assemblies that are free from internal stresses and which can be installed with or without integrated radiant heating tubes. These systems allow the installation of continuous screed surfaces without any control joints or reinforcing wire. The BEKOTEC panels are 1-3/8" (35 mm) thick and made of expanded polystyrene, whereas the BEKOTEC-F panels are 29/32" (23 mm) thick and made of thin polystyrene foil.



PROFILE OF INNOVATION

Schluter Systems L.P. • 194 Pleasant Ridge Road, Plattsburgh, NY 12901-5841 Tel.: 1-800-472-4588 • Fax: 1-800-477-9783
Schluter Systems (Canada) Inc. • 21100 ch. Ste-Marie, Ste-Anne-de-Bellevue, QC H9X 3Y8 • Tel.: 1-800-667-8746 • Fax: 1-877-667-2410
e-mail: info@schluter.com

www.schluter.com