



## INNOVATIVE SOLUTIONS FOR CERAMIC AND STONE TILE

### INTEGRATED BONDED WATERPROOFING SYSTEM FOR TILED SHOWERS

The Schluter®-Shower System is an integrated family of products that together form a fully bonded, watertight assembly for tiled showers. Unlike shower pan liners in conventional assemblies, bonded waterproof membranes, such as Schluter®-KERDI, bond directly to the mortar bed and protect it from becoming saturated with regular use. In addition, the KERDI membrane or Schluter®-KERDI-BOARD waterproof building panel protects wall cavities from vapor penetration. The Schluter®-KERDI-DRAIN, Schluter®-KERDI-DRAIN-H, Schluter®-KERDI-LINE, and Schluter®-KERDI-LINE-VARIO shower drains provide a simple and secure connection to the KERDI membrane at the top of the assembly. Other components include the Schluter®-KERDI-SEAL-PS/-MV prefabricated seals and the Schluter®-KERDI-FIX adhesive/sealant, used to treat protrusions through the membrane, and the Schluter®-KERDI-SHOWER and Schluter®-KERDI-BOARD prefabricated substrates, which can reduce weight and installation time. The integrated Schluter®-Shower System eliminates leaks, reduces the potential for efflorescence and mold growth in the system, and dramatically reduces total installation time to ensure success and make shower installation easier than ever.



17.1 Schluter®-SHELF-E/-W/-N



8.1 Schluter®-KERDI

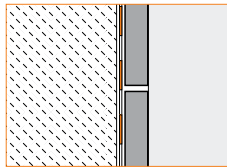

8.2 Schluter®-KERDI-DRAIN



8.7 Schluter®-KERDI-LINE



8.8 Schluter®-KERDI-LINE-VARIO



8.2 Schluter®-KERDI-DRAIN-H

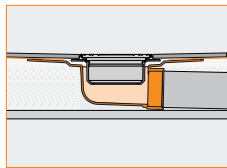

12.1 Schluter®-KERDI-BOARD

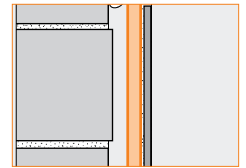

8.3 Schluter®-KERDI-SHOWER-T/-TS/-TT



8.8 Schluter®-KERDI-SHOWER-LT/-LTS



12.1 Schluter®-KERDI-BOARD  
-SB/-SC/-SN/-SNLT



8.1 Schluter®-KERDI-SEAL-PS/-MV



8.3 Schluter®-KERDI-SHOWER  
-R/-CB



14.1 Schluter®-SHOWERPROFILE  
-W/-WSK



8.1 Schluter®-KERDI-BAND/  
-KERECK/-KERS



14.1 Schluter®-SHOWERPROFILE-S/-R



## Prefabricated Shower Substrates



### 8.3 Schluter®-KERDI-SHOWER-T/-TS/-TT



### 8.3 Schluter®-KERDI-SHOWER-R/-CB



### 8.8 Schluter®-KERDI-SHOWER-LT/-LTS



### 12.1 Schluter®-KERDI-BOARD-SB/-SC



### 12.1 Schluter®-KERDI-BOARD-SN/-SNLT



### Schluter®-KERDI-BOARD-KIT

Schluter® prefabricated shower substrates provide an alternative to shower bases constructed of mortar and other shower elements constructed of framing and solid backing. The shower tray, curb, ramp, bench, and niche are especially useful in large-scale, repetitive jobs, such as hotels, apartments, and condominiums for the significant time savings that can be realized.

### 8.3 Schluter®-KERDI-SHOWER-T/-TS/-TT/-LT/-LTS

Property	Method	Value
Density	ASTM D3575	3.75 lb/ft <sup>3</sup> (60 Kg/m <sup>3</sup> )
Compressive Strength <sup>1</sup>	ASTM D1621	80 psi (552 kPa)
Maximum Service Temperature	-	175 °F (79 °C)

<sup>1</sup> Compressive strength measured at 10% deflection of foam

### 8.3 Schluter®-KERDI-SHOWER-R

Property	Method	Value
Density	ASTM D3575	3.75 lb/ft <sup>3</sup> (60 Kg/m <sup>3</sup> )
Maximum Service Temperature	-	175 °F (79 °C)

## Application and Function

**8.3 Schluter®-KERDI-SHOWER-T/-TS/-TT** are sloped shower trays with integrated KERDI waterproofing. The trays are made of lightweight, expanded polystyrene for constructing mortar-free shower bases. Each of these shower trays are designed to integrate with Schluter®-KERDI-DRAIN. The trays include a KERDI collar for completing the waterproofing to the Schluter®-KERDI-DRAIN bonding flange.

KERDI-SHOWER-T is a standard tray with center drain placement available in 38" x 60" (97 x 152 cm), 48" x 60" (122 x 152 cm), 48" x 72" (122 x 183 cm), 60" x 60" (152 x 152 cm), and 72" x 72" (183 x 183 cm) sizes.

KERDI-SHOWER-TS is the standard tray with off-center drain placement available in a 38" x 60" (97 x 152 cm) size.

KERDI-SHOWER-TT features a thin perimeter height that simplifies construction of curbless showers. The tray is available in 32" x 38" (81 x 97 cm), 36" x 48" (91 x 122 cm), 36" x 36" (91 x 91 cm), 38" x 38" (97 x 97 cm), and 48" x 48" (122 x 122 cm) and neo-angle 38" x 38" (97 x 97 cm) sizes.

**8.3 Schluter®-KERDI-SHOWER-R** is a lightweight, expanded polystyrene shower ramp with integrated Schluter®-KERDI waterproofing designed to facilitate the construction of access ramps for tiled showers. The ramp integrates with the Schluter®-Shower System to create accessible, curbless showers and adheres to the ADA's slope ratio. Ramp dimensions are 48" x 12" x 1-1/4" (122 x 30.5 x 3.2 cm).

**8.8 Schluter®-KERDI-SHOWER-LT/-LTS** are polystyrene sloped trays with integrated Schluter®-KERDI waterproofing. Each of these prefabricated shower trays is designed to integrate with the Schluter®-KERDI-LINE.

KERDI-SHOWER-LT allows for the installation of a center drain and is available in 39" x 39" (100 x 100 cm), 48" x 48" (122 x 122 cm) and 55" x 55" (140 x 140 cm) sizes.

KERDI-SHOWER-LTS accommodates the installation of the drain along the perimeter of the shower and is available in 39" x 39" (100 x 100 cm), 48" x 48" (122 x 122 cm) and 55" x 55"

(140 x 140 cm), 36" x 55" (91 x 140 cm), 36" x 72" (91 x 183 cm), 38" x 76" (97 x 193 cm) and 76" x 38" (193 x 97 cm) sizes.

**Schluter®-KERDI-SHOWER-CB** is a height compensation board made of lightweight expanded polystyrene used to accommodate the drain body and waste pipe height, when installing the Schluter®-KERDI-DRAIN-H in conjunction with the Schluter®-KERDI-SHOWER-T/-TS/-TT shower trays. The compensation board can easily be cut to size to fit around the drain and waste pipe, and multiple boards can be used to fit the size and shape of the shower.

**12.1 Schluter®-KERDI-BOARD-SB/-SC** are prefabricated substrates, made of Schluter®-KERDI-BOARD, which integrate with the Schluter®-Shower System. The substrates are waterproof and ready for tile, leaving only sealing of joints and corners to complete waterproofing. The KERDI-BOARD-SB shower bench is available in triangular and rectangular configurations in the followings sizes (width x depth x height). The triangular benches are 16" x 16" x 20" (41 x 41 x 51 cm) and 24" x 24" x 20" (61 x 61 x 51 cm). Rectangular benches are 38" x 11-1/2" x 20" (97 x 29 x 51 cm) and 48" x 16" x 20" (122 x 41 x 51 cm). The KERDI-BOARD-SC shower curb can be used in conjunction with any shower base. Curb dimensions are 38" x 6" x 4-1/2" (97 x 15 x 11.5 cm), 48" x 6" x 4-1/2" (122 x 15 x 11.5 cm), and 60" x 6" x 4-1/2" (152 x 15 x 11.5 cm).

**12.1 Schluter®-KERDI-BOARD-SN** is a prefabricated shower niche made of KERDI-BOARD that can be installed in both KERDI and KERDI-BOARD wall assemblies. The shower niche features a 1/2" (12.5 mm) -thick by 2" (50 mm) -wide integrated bonding flange and is available in 12" x 6" (30 x 15 cm), 12" x 12" (30 x 30 cm), 12" x 20" (30 x 51 cm), and 12" x 28" (30 x 71 cm) sizes. All KERDI-BOARD-SN niches include screws and washers, as well as a pre-cut KERDI-BAND frame for waterproofing the transition of the niche to the adjacent wall.

**Schluter®-KERDI-BOARD-SNLT** is a prefabricated shower niche made of KERDI-BOARD that incorporates a profile with a diffused LED light strip. See the Schluter®-KERDI-BOARD-SNLT Shower Niche with LIPROTEC

LED Lighting technical data sheet for more product and warranty information.

**Schluter®-KERDI-BOARD-KIT** combines all of the necessary components to waterproof the walls of your bathtub and acrylic shower base using waterproof building panels. The kit includes 1/2" x 48" x 38" (1.25 cm x 122 cm x 97 cm) KERDI-BOARD waterproofing panels, KERDI-BAND, pipe and mixing valve seals, screws and washers, plus 9.81 fl oz (290 ml) of KERDI-FIX sealant in bright white. The KERDI-BOARD-KIT provides enough KERDI-BOARD to cover up to 101 ft<sup>2</sup> (9.4 m<sup>2</sup>) of wall area.

### Material Properties and Areas of Application

KERDI-SHOWER-T/-TS/-TT/-LT/-LTS/-R prefabricated substrates are manufactured using lightweight expanded polystyrene. The products require no special disposal and can be recycled. No CFCs or HCFCs are present in either the products or in the manufacturing process. The polystyrene foam trays and the shower ramp each have a density of 3.75 lb/ft<sup>3</sup> (60 kg/m<sup>3</sup>) with an 80 PSI (552 kPa) compressive strength at 10% deformation. It is serviceable in temperatures up to 175°F (79°C). The expanded polystyrene used to manufacture KERDI-SHOWER-T/-TS/-TT/-LT/-LTS/-R is treated with a flame retarding agent. Expanded polystyrene should not be exposed to hydrocarbons, esters, amines, and aldehydes. All will deteriorate foam. Exposure to ultraviolet rays (sunlight) for long periods of time will result in partial degradation (dusting) at the surface.

KERDI-BOARD-SB/-SC prefabricated substrates are manufactured using KERDI-BOARD, made from extruded polystyrene foam, with a cement-free reinforcement layer laminated to both sides with an anchoring fleece webbing. The surface features printed gridlines consisting of 3/8" x 3/8" (10 x 10 mm) squares for precise cutting. KERDI-BOARD is waterproof and vapor-retardant and can withstand all chemical stresses that typically occur in conjunction with ceramic tile coverings. KERDI-BOARD will not warp, rot, or decay. It is serviceable in temperatures up to 158°F (70 °C).

### Waterproofing Membrane

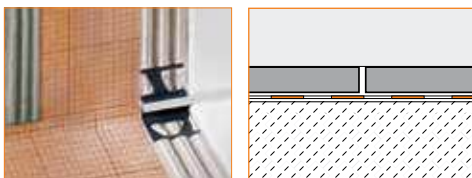

#### 8.1 Schluter®-KERDI

Since traditional shower pan liners are placed below the mortar setting bed in conventional assemblies, moisture is allowed to saturate the mortar bed. This can increase the risk of leakage, cause efflorescence, and foster mold growth. Bonded waterproof membranes, such as KERDI, are set on top of the mortar

bed and protect it from becoming saturated, thus eliminating the problems associated with traditional systems.

### Application and Function

**8.1 Schluter®-KERDI** is a pliable, sheet-applied, bonded waterproof membrane and vapor retarder with limited crack-bridging capabilities. It is made of soft polyethylene, which is covered on both sides with a special fleece webbing to anchor the membrane in the thin-set mortar. Tiles can be installed directly on the KERDI membrane using the thin-bed method. Other trowel-applied covering materials, such as plaster, can also be used. **Schluter®-KERDI-DS** is a bonded waterproof membrane and vapor retarder with very low water vapor permeance for use in continuous use steam rooms and similar applications.

Various KERDI waterproofing accessories are available. Preformed, seamless corners include the following. KERDI-KERECK-F are used to seal 90° inside and outside corners. KERDI-KERS-B are used to seal 135° corners at triangular shower benches and neo-angle shower curbs. KERDI-KERS are used to seal floor/wall/shower base connections in curbless shower applications where the KERDI-LINE linear drain is installed adjacent to the wall. KERDI-SEAL-PS/-MV are prefabricated sections of KERDI with overmolded rubber gaskets that are used to seal pipe protrusions through the KERDI waterproofing membrane (e.g., at showerheads and tub spouts) and protect moisture-sensitive backing panels at the mixing valve. Use KERDI-BAND, in widths of 5" (12.5 cm), 7-1/4" (18.5 cm), or 10" (25 cm), to seal butt joints or corner joints. KERDI-FLEX, in 5" (12.5 cm) or 10" (25 cm) widths, is used to seal expansion joints or flexible edge joints.

### Material Properties and Areas of Application

KERDI features a modified polyethylene (PEVA) core with non-woven polypropylene on both sides. KERDI-DS features a high-density polyethylene (HDPE) core with non-woven polypropylene on both sides. KERDI is 8-mil thick and has a water vapor permeance of 0.90 perms, when tested according to ASTM E96, using Procedure E at 90% relative humidity. KERDI-DS is 20-mil thick and features additives to produce a water vapor permeance of 0.18 perms.

KERDI and KERDI-DS are waterproof and resistant to most chemicals commonly encountered in tiled environments. They are resistant to aging and will not rot. KERDI and KERDI-DS are highly resistant to saline solutions, acid and alkaline solutions, many organic solvents, alcohols, and oils. Information regarding their resistance to specific substances can be provided if concentration, temperature, and duration of exposure are known. For acid-

resistant coverings, use an epoxy adhesive to set and grout the tile.

KERDI and KERDI-DS are used on wall and floor surfaces where protection against the penetration of moisture or other harmful substances is necessary. KERDI is suitable for showers, intermittent use steam showers, tub surrounds, and areas surrounding swimming pools. Industrial applications include the food industry, breweries, and dairies. KERDI-DS is suitable for use in continuous use steam rooms and other applications with similar vapor management requirements.

KERDI and KERDI-DS meet the American National Standard for Load Bearing, Bonded, Waterproof Membranes for Thin-Set Ceramic Tile and Dimension Stone Installations (ANSI A118.10). The membranes are listed by cUPC® and evaluated by ICC-ES (Report Nos. ESR-2467 and PMG-1204). For copies of these documents, please contact Schluter®-Systems at 800-472-4588 (USA) or 800-667-8746 (Canada) or by e-mail at info@schluter.com. Links to the documents can also be accessed at www.schluter.com.

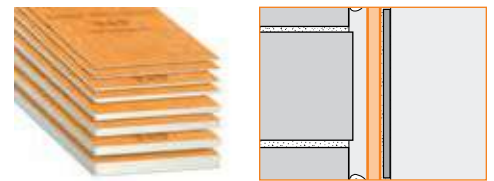

#### 12.1 Schluter®-KERDI-BOARD

KERDI and KERDI-DS have been evaluated according to the "Standard Method for the Testing and Evaluation of Volatile Organic Chemical Emissions from Indoor Sources Using Environmental Chambers, Version 1.1" for California Specification 01350 and found to comply with the VOC requirements. California Specification 01350 is referenced by various green building standards and rating systems.

### Waterproof Building Panel

The KERDI-BOARD waterproof building panel simplifies shower installation by combining the tile backing and waterproofing installation into a single step. KERDI-BOARD gives tile setters more control over their projects by providing them with the means to simply and easily create ideal substrates for tile. Unsuitable substrates can be remedied and new substrates can be created while keeping the requirements of the tile covering in mind.

### Application and Function

**12.1 Schluter®-KERDI-BOARD** is a multifunctional tile substrate and building panel, which can also be used for creating bonded waterproofing assemblies with tile coverings. It consists of an extruded polystyrene foam panel, with a special reinforcement material on both





sides and fleece webbing for effective anchoring in thin-set mortar.

With the available panel thicknesses of 3/16", 3/8", 1/2", 5/8", 3/4", 1", 1-1/2", and 2" (5, 9, 12.5, 15, 19, 25, 38, and 50 mm), KERDI-BOARD covers a broad range of application areas for creating flat, level, plumb, square, and dimensionally stable substrates for the installation of ceramic and natural stone tiles. With suitable preparation of the abutting seams and joint areas, the panel may be used for bonded waterproofing assemblies.

KERDI-BOARD is suitable for: creating tile substrates on masonry walls, wood or metal framing, and other finished wall surfaces; creating straight or curved partition walls; creating straight or curved bathtub and shower surrounds; concealing pipes and columns; as well as creating bathtub platforms, vanities, storage shelves, countertops, and various other bathroom structures.

The boards are simply cut to size with a utility knife. The gridlines, which are printed on the surface, are helpful for neat and quick cuts and installation. KERDI-BOARD can be fully adhered in wall areas or spot-bonded with thin-set mortar. If necessary, the material may be secured with additional wall anchors. In the case of stud framing, KERDI-BOARD is attached with screws and washers from the matching hardware system. Tiles can be installed directly over KERDI-BOARD using the thin-set method.

L-shaped and U-shaped KERDI-BOARD panels are available for creating pipe and column coverings, and grooved panels are available for creating curved elements. Schluter®-Systems also offers profiles and attachment hardware for wall connections and finishing edges, as well as matching wall anchors and screws.

## Material Properties and Areas of Application

KERDI-BOARD is made from extruded polystyrene foam, with a cement-free reinforcement layer laminated to both sides and an anchoring fleece webbing. The surface of the board has gridlines consisting of 3/8" x 3/8" (10 x 10 mm) squares printed on one side.

KERDI-BOARD is waterproof and vapor retardant and can withstand all chemical stresses that typically occur in conjunction with ceramic tile coverings. KERDI-BOARD may be used in bonded waterproofing assemblies where required. KERDI-BOARD is completely flat and will not warp, even with one-sided exposure to temperature and moisture fluctuations. It will not rot or decay. KERDI-BOARD can be used in a multitude of different application areas. In special cases, the suitability of the material must be verified based on the anticipated chemical and mechanical stresses. The information provided below is intended as general guidelines.

## 12.1 Schluter®-KERDI-BOARD

Property	Method	Value
Water vapor permeance	ASTM E96 <sup>1</sup>	0.36 perms - 1/2" (12.5 mm)
Thermal resistance (R-value)	ASTM C518	R 9.1 - 2" (50 mm) R 2.2 - 1/2" (12.5 mm) R 0.9 - 3/16" (5 mm)
Service temperature range		-58°F to 158°F (-50°C to 70°C)
Flame spread/smoke developed	ASTM E84	Pass <sup>2</sup>
Thermal barrier evaluation	NFPA 286	Pass <sup>2,3</sup>

<sup>1</sup> Using the desiccant method at 100°F (38°C) and 90% RH

<sup>2</sup> Per International Building Code Requirements

<sup>3</sup> Porcelain tile used as thermal barrier over 1/2" (12.5 mm) -thick KERDI-BOARD on wood framing

Structures on which KERDI-BOARD is to be installed must be stable and meet any other project-specific requirements. Select a suitable material thickness if using KERDI-BOARD for the construction of freestanding partition walls, shelving, or similar structures, and use reinforcement profiles as necessary. Arrange supports made of KERDI-BOARD at regular intervals consistent with conventional building practices. Select the material thickness and installation method depending on the evenness of the substrate. KERDI-BOARD can be spot-bonded to walls to correct substrate variations or fully embedded in thin-set mortar where walls are sufficiently even and plumb.

## Maintenance

### Storage

KERDI-BOARD should be stored flat. In case of outdoor storage, protect the material from direct sunlight and weather exposure.

## Shower Drains



### 8.2 Schluter®-KERDI-DRAIN



### Schluter®-KERDI-DRAIN-H

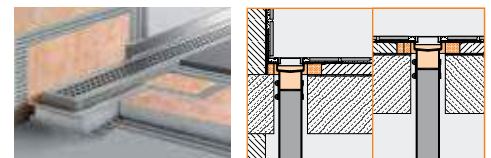

### 8.7 Schluter®-KERDI-LINE



### 8.8 Schluter®-KERDI-LINE-VARIO

Conventional two-stage drains are designed to connect to shower pan liners below the mortar bed and do not allow a secure, watertight connection to bonded waterproof membranes at the top of the drain assembly. KERDI-DRAIN, KERDI-DRAIN-H, KERDI-LINE, and KERDI-LINE-VARIO are designed specifically to ensure a simple and secure connection to bonded waterproof membranes, such as KERDI, at the top of the assembly rather than below it, thereby reducing the risk of leakage, efflorescence, and mold growth.

## Application and Function

**8.2 Schluter®-KERDI-DRAIN** is a shower drain specifically designed to allow connections to KERDI or other load-bearing, bonded waterproof membranes. The membrane is adhered to the large integrated bonding flange to form a waterproof connection at the top of the drain



assembly. KERDI-DRAIN consists of a drain body and fully adjustable grate assembly or covering support to which tile is applied. The grate assembly accommodates a wide range of tile thicknesses and allows lateral and tilt adjustment as well. The covering support is placed flush with the top of the bonding flange and can therefore accommodate any thickness tile covering.

The standard KERDI-DRAIN is attached directly to the waste line. The drain body is available in ABS, PVC, or stainless steel. The plastic drain bodies feature a fleece-covered bonding flange. They are available with standard 2" (50 mm) and 3" (75 mm) outlets and attached to the pipe using an appropriate solvent cement. The stainless steel drain bodies are available with standard 2" (50 mm) or 3" (75 mm) no-hub outlets or 2" (50 mm) threaded outlet. The no-hub outlets are attached to the pipe using an appropriate mechanical (e.g., flexible or no-hub) coupling. The threaded outlets are attached to the pipe using thread sealing compound or tape. The simple connection to standard drain outlets makes KERDI-DRAIN suitable for new construction and renovation.

The Schluter®-KERDI-DRAIN-A adaptor kits are designed to convert clamping ring drains to integrated bonding flange drains when removal of the clamping ring drain is not practical (e.g., when they are set in concrete slabs). The adaptor kit includes a stainless steel adaptor ring, available in 5-1/4" (133 mm) and 7-1/2" (191 mm) diameter sizes, with an over-molded rubber gasket and a variety of perforated hole patterns that align with most common clamping ring drains. The adaptor ring replaces the clamping ring and is attached to the existing drain body using the clamping ring bolts. This connection is made watertight via the rubber gasket and Schluter®-KERDI-FIX adhesive/sealant. The adaptor drain with integrated bonding flange slides into the adaptor ring with the over-molded rubber gasket ensuring a watertight seal. Adaptor kits are suitable for both mortar beds and KERDI-SHOWER-T/-TS/-TT shower tray applications.

The KERDI-DRAIN grate assembly consists of a frame, which can be seamlessly adjusted to the thickness and layout of the ceramic tile or stone covering via the height adjustment collar and lateral adjustment ring and grates or cleanout covers that are placed within the frame. The 4" (100 mm) standard grate assembly frame features an approximately 1/8" (3 mm) wide reveal after installation and grate/frame combinations are available in stainless steel in CLASSIC design or anodized aluminum in CONTOUR design, both available in a variety of finishes. The 4" (100 mm) KERDI-DRAIN-STYLE grate assembly frame features a minimal reveal after installation. It is made of brushed stainless steel and can be combined with one of three grate design options: FLORAL (E), CURVE (F), or PURE (G). Various metallic and color-coated finishes are available.

The 4" (100 mm) TILE grate is a square stainless steel plate with KERDI laminated on the surface to allow for bonding of ceramic or stone tile, which creates a virtually invisible drainage line. The 6" (150 mm) square and round stainless steel grate assembly frames feature an approximately 3/16" (5 mm) wide reveal after installation and can be combined with stainless steel grates in CLASSIC design or a square cleanout cover. Please note that 6" (150 mm) grate assemblies and grate assemblies used with the 5-1/4" (133.4 mm) adaptor kits only allow vertical and tilt adjustment (no lateral adjustment).

**Schluter®-KERDI-DRAIN-H** is a shower drain with an integrated bonding flange that provides as large contact area for a secure connection to Schluter®-KERDI waterproof membrane at the top of the assembly. KERDI-DRAIN-H is appropriate for both mortar bed and Schluter®-KERDI-SHOWER-T/-TS/-TT shower tray applications. The bonding flange is sloped to simplify installation of the mortar bed.

KERDI-DRAIN-H provides a horizontal connection to the drain pipe and is available in ABS or PVC with a 2" (50 mm) outlet. It is ideal for applications where the use of a vertical connection to the drain pipe is not possible or practical (e.g., suspended or post-tension concrete floors, basement slabs, or wood floor installations where relocating the hole in the floor is not practical). The horizontal outlet allows the positioning of the drain in the desired area regardless of drain pipe location.

A compensation board is available for use with KERDI-DRAIN-H in conjunction the KERDI-SHOWER-T/-TS/-TT shower trays.

KERDI-DRAIN-H is compatible with the standard KERDI-DRAIN grate options. Please refer to the previous section on KERDI-DRAIN for details.

**8.7 Schluter®-KERDI-LINE** is a low profile linear shower drain specifically designed for bonded waterproofing assemblies. KERDI-LINE can be installed adjacent to walls or at intermediate locations. The floor can be sloped on a single plane to KERDI-LINE, which enables the use of large-format tiles and creates interesting design opportunities.

KERDI-LINE consists of a formed stainless steel channel body and grate assembly or covering support to which tile is applied.

The channel body features a standard 2" (50 mm) no-hub outlet and is attached to the pipe using an appropriate mechanical (e.g., flexible or no-hub) coupling. The simple connection to standard drain outlets makes KERDI-LINE suitable for new construction and renovation. KERDI-LINE is available with both center and off-set outlets. The off-set outlet is located 8" (20.3 cm) from the edge of the channel body and provides flexibility when obstacles (e.g., floor joists) are encountered during installation. KERDI-

LINE includes a corresponding polystyrene foam channel support to set the drain elevation to the corresponding KERDI-SHOWER-LT/-LTS shower trays. The perimeter of the channel body consists of a bonding flange laminated with a collar made of KERDI. It ensures a simple and secure connection to the bonded waterproofing assembly, both in the floor area and on adjacent walls. KERDI-LINE is available in channel lengths from 20" to 72" (50 cm to 180 cm) in 4" (10 cm) increments. The bonding flange extends approximately 1" (2.5 cm) beyond the channel on all sides.

The KERDI-LINE grate assembly consists of a stainless steel frame that can be seamlessly adjusted to the thickness of the ceramic tile or stone covering – 1/8" to 1" (3 mm to 25 mm) for standard grate assemblies and 1/4" to 23/32" (6 mm to 18 mm) for KERDI-LINE-STYLE grate assemblies – and stainless steel grates that are placed within the frame. The standard grate assembly frame features a 3/8" (10 mm) wide reveal after installation and can be combined with one of two grate options: SOLID (A) or SQUARE (B). Each standard assembly is available in a brushed, chrome, or textured color-coated finish. The SQUARE (B) option is also available with a locking mechanism (brushed stainless steel, 3/4" – 19 mm frame only) for applications where tamper resistance is desired or required (e.g., healthcare and education facilities, etc.). The KERDI-LINE-STYLE grate assembly frame features a minimal reveal after installation and can be combined with one of three grate options: FLORAL (E), CURVE (F), or PURE (G). Each STYLE assembly is available in a brushed finish. The TILE grate (D) consists of a frameless, tileable covering support that is placed flush with the top of the channel body and can therefore accommodate any thickness tile covering. If KERDI-LINE is placed at shower entrance, it is recommended that grate assembly A or the TILE grate is chosen and that the drainage openings span the maximum width of the entrance to limit potential overflow; secondary drainage (e.g., KERDI-DRAIN-F) may be required in the drying area.

**8.8 Schluter®-KERDI-LINE-VARIO** is a lowprofile, variable length linear shower drain specifically designed for bonded waterproofing assemblies. KERDI-LINE-VARIO can be initially cut to size onsite to fit the specific dimensions of the shower. The floor can be sloped on a single plane to KERDI-LINE-VARIO, which enables the use of large-format tiles and creates interesting design opportunities. KERDI-LINE-VARIO is best suited for placement against the wall but can also be installed in the center of the shower. For drain placement at the entrance of the shower, please refer to the 8.7 KERDI-LINE linear drain.

KERDI-LINE-VARIO consists of a polypropylene flange, a formed stainless steel channel, a stainless steel grate, and stainless steel end caps for applications involving trimmed lengths.



The KERDI-LINE-VARIO flange comprises an injection molded polypropylene drain body featuring a standard 2" (50 mm) NPT outlet, which attaches to a standard, threaded, mechanical coupling to allow for an adhesive chemical bond to the drainpipe. KERDI-LINE-VARIO is supplied with PVC and ABS couplings. The simple connection makes KERDI-LINE-VARIO suitable for new construction and renovations. The perimeter of the polypropylene flange consists of a bonding flange laminated with a collar made of KERDI. This ensures a simple and secure connection to the bonded waterproofing assembly, both in the floor area and on adjacent walls. The KERDI-LINE-VARIO flange kit contains corresponding polystyrene foam supports to set the drain elevation to the corresponding KERDI-SHOWER-LT/-LTS shower trays.

The KERDI-LINE-VARIO channel features a formed stainless steel design 1-11/16" wide by 3/8" high (43 mm wide by 10 mm high) with a drainage opening cut in the center. The channel comes in lengths of 48" and 96" (122 cm and 244 cm) and is designed to be trimmed to length to ensure a proper fit in custom applications. The flange outlet may be positioned anywhere within the overall trimmed length of the channel to avoid obstacles encountered during construction (e.g., floor joists).

The KERDI-LINE-VARIO grate is a formed stainless steel design that nests into the corresponding channel. The overall length of the grate must be trimmed to the same length as the channel. If the grate is trimmed, the supplied end caps should be used to provide a clean finished look. The KERDI-LINE-VARIO grate assembly features a minimal reveal after installation and is available in four designs: Square, Floral, Herringbone, and Slant, in a brushed stainless steel finish (EB).

KERDI-LINE-VARIO drains are designed to meet the International Plumbing Code (IPC) guideline for a single standard showerhead with a maximum flow of 2.5 gpm (9.5 L/m).

KERDI-LINE is recommended for showers that exceed the International Plumbing Code (IPC) guideline for a single standard showerhead with a maximum flow rate of 2.5 gpm (9.5 L/m). Perfect for showers that include multiple shower heads, body sprays, hand wands, etc., KERDI-LINE features a wider and deeper design to accommodate higher input water flow.

#### Notes:

- The shortest allowable length to cut the channel and grate is 10" (25.4 cm).
- The minimum recommended tile thickness to use with the KERDI-LINE-VARIO channel is 3/8" (10 mm).

**Schluter®-KERDI-LINE-FC** is a stainless steel cover plate for use with KERDI-LINE to create

a seamless look in applications where multiple drains are installed end-to-end. KERDI-LINE-FC is available in a brushed, chrome, or textured color-coated finish and is designed for use with either the SOLID (A) or SQUARE (B) grates.

**14.1 Schluter®-SHOWERPROFILE-S/-R** system profiles represent an elegant solution for finishing the area between the floor and the first course of wall tile in a way that eliminates cutting wedges of tile and ensures a consistent elevation of the first course of wall tile in KERDI-LINE applications. SHOWERPROFILE-S consists of a trapezoid-perforated anchoring leg with a groove, which accepts a tapered brushed stainless steel profile that matches the slope of the KERDI-SHOWER-LTS shower tray. The profile is adjusted to cover the exposed wall area and forms the visible surface. SHOWERPROFILE-R consists of a brushed stainless steel profile and corresponding channel. The profile is adjusted to fit the space between the KERDI-LINE and the wall tile and forms the visible surface in applications where the KERDI-LINE is placed adjacent to a wall.

### Material Properties and Areas of Application

KERDI-DRAIN, KERDI-DRAIN-H, KERDI-LINE, and KERDI-LINE-VARIO are suitable for use in residential and commercial applications, including areas subject to foot and wheelchair traffic, such as showers and wet rooms in homes, hotels, schools, healthcare facilities, etc.

Various configurations of KERDI-DRAIN, KERDI-DRAIN-H, KERDI-LINE, and KERDI-LINE-VARIO are listed by UPC®, CSA, and ICC-ES PMG. Relevant industry standard guidelines for floor drains with integrated bonding flange include methods B422, B422C, SR613 and SR614 in the Tile Council of North America's (TCNA) Handbook for Ceramic Tile Installation and Method 326DR in the Terrazzo, Tile and Marble Association of Canada (TTMAC) Specification Guide 093000 Tile Installation Manual.

KERDI-DRAIN drain flanges are formed using ABS, PVC, or stainless steel 304 (1.4301 = V2A). KERDI-DRAIN-H flanges are formed using ABS or PVC. Plastic drain bodies feature a polypropylene fleece webbing on the surface of the bonding flange to accept a bond to thin-set mortar. The KERDI-DRAIN adaptor kits feature adaptor rings made of stainless steel 304 (1.4301 = V2A) with thermoplastic rubber gaskets and adaptor flanges made of ABS. Drain grates are available in plain and coated stainless steel 304 (1.4301 = V2A) and anodized aluminum. The covering support is stainless steel 304 (1.4301 = V2A) with KERDI laminated on the surface.

The KERDI-LINE channel body is formed using stainless steel 316 L (1.4404 = V4A) and features a bonding flange with a KERDI collar laminated on the surface. KERDI is a bonded waterproof

membrane with a modified polyethylene (PEVA) with non-woven polypropylene fleece on both sides to anchor the membrane in the thin-set mortar. The frame and grates are made of stainless steel 316 L (1.4404 = V4A). The channel support is made of pressure-resistant, expanded polystyrene (EPS). The KERDI-LINE-FC cover plate is roll-formed using stainless steel 316 L (1.4404 = V4A). The SHOWERPROFILE-S anchoring leg is made of recycled, rigid PVC. The SHOWERPROFILE-S/-R profiles are made of stainless steel 316 L (1.4404 = V4A) with KERDI laminated on the backside.

The KERDI-LINE-VARIO channel, grates, and grate end caps are formed using stainless steel 316 (1.4404 = V4A).

The KERDI-LINE-VARIO flange comprises an injection molded polypropylene drain body featuring a 2" (50 mm) NPT outlet, which attaches a standard, threaded, mechanical coupling to allow for an adhesive chemical bond to the drain pipe.

The flange features a bonding flange with a KERDI collar laminated on the surface. KERDI is a bonded waterproof membrane with a modified polyethylene (PEVA) with non-woven polypropylene fleece on both sides to anchor the membrane in the thin-set mortar.

The foam support channel is made of pressure-resistant, expanded polystyrene (EPS).

KERDI-LINE-VARIO drains are designed to meet the International Plumbing Code (IPC) guideline for a single standard showerhead with a maximum flow of 2.5 gpm (9.5 L/m).

KERDI-LINE is recommended for showers that exceed the International Plumbing Code (IPC) guideline for a single standard showerhead with a maximum flow rate of 2.5 gpm (9.5 L/m). Perfect for showers that include multiple shower heads, body sprays, hand wands, etc., KERDI-LINE features a wider and deeper design to accommodate higher input water flow.

Schluter®-Systems drain grates are resistant to most chemicals encountered in tiled environments. In special cases, the suitability of a proposed type of material must be verified based on the anticipated chemical, mechanical, and/or other stresses. In general, grates should be protected against abrasion or scratching. Exceptions and special considerations are listed below.

**Stainless steel** can sustain high mechanical stresses and is particularly well suited for applications requiring resistance against chemicals and acids. For more severe chemical exposure, such as de-icing salts and chemicals used in swimming pools, we recommend the use of stainless steel 316 L, which offers even higher corrosion resistance than the 304. Even stainless steel cannot withstand all chemical exposures, such as hydrochloric acid, hydrofluoric acid or certain chlorine, chloride and brine concentrations.



**Metallic-coated** grates are stainless steel 304 with a metallic coating created using physical vapor deposition (PVD). The resulting metallic film is very hard and corrosion-resistant.

**Textured color-coated** grates are stainless steel with a powder coat. Textured color-coated shelves are aluminum with a powder coat. The coating is color-stable, UV-resistant, and suitable for exterior use. Protect the profile against abrasion or scratching.

**Anodized aluminum** grates feature an anodized layer that retains a uniform appearance during normal use. The surface may be damaged by grout or setting material. Therefore, these materials must be removed immediately.

## Maintenance

KERDI-DRAIN, KERDI-DRAIN-H, KERDI-LINE, KERDI-LINE-VARIO, and SHOWERPROFILE-S/-R require no special maintenance and are resistant to mold and fungi. The drain grates may be removed to clean the drain housing and the drain pipes.

Clean the grates and profiles using neutral cleaners. Avoid the use of strong acids (e.g., hydrochloric, hydrofluoric) and bases/alkaline cleaners (e.g., bleach, ammonia, chlorides). Do not use abrasive cleaning agents and tools. Even stainless steel requires periodic cleaning, which will maintain a neat appearance and reduce the risk of corrosion. Stainless steel surfaces develop a sheen when treated with a chrome-polishing agent.

## Shelves



### 17.1 Schluter®-SHELF-E/-W/-N

#### Application and Function

**17.1 Schluter®-SHELF** is a wall storage system available in brushed stainless steel or aluminum in a range of textured color-coated finishes including stone grey, cream, greige, bronze, matte black, and matte white. The shelves are 5/32" (4 mm) -thick and feature CURVE, FLORAL, PURE, WAVE, and SQUARE designs. They can be used in showers and other tiled wall applications (e.g., kitchens and baths). Schluter®-SHELF-E is suitable for corner installations and available in three different shapes. It features 3/32" (2 mm) -thick tabs that allow for installation with the tile or in retrofit applications. Schluter®-SHELF-W is a rectangular shelf with two trapezoid-perforated anchoring legs for installation on walls in conjunction with the tile. Schluter®-SHELF-N is a rectangular shelf that fits the prefabricated

## Schluter®-KERDI-FIX Technical Data

Color	Grey or bright white
Basic raw material	Silyl-modified polymer (SMP)
Specific weight	Approx. 93.6 lb/ft <sup>3</sup> (1.5 g/ml)
Solvent content	0%
Isocyanate content	0%
Dry materials content	Approx. 100%
VOC emissions	0.0 mg/m <sup>3</sup>
Shear strength beech wood/beech wood	Approx. 435 psi (3 N/mm <sup>2</sup> )
Shear strength aluminum/aluminum	Approx. 290 psi (2 N/mm <sup>2</sup> )
Elongation at failure	Approx. 200%
Skinning	About 10 minutes
Curing	1/8" (3 mm) per 24 hours
Permissible total movement	About 20%
Processing temperatures	Don't install at temperatures below 40 °F (5 °C)
Temperature stability	-40 °F (-40 °C) to 212 °F (100 °C), temporarily 356 °F (180 °C) [max. 30 minutes]
Moisture resistance	Very good
Frost ability	Not sensitive to frost
Cartridge volume	9.81 fl oz (290 ml)
<b>Estimated coverage</b>	
5" (12.7 cm) connection to fixed building elements	12' 10" (3.9 m) per cartridge
1/4" (6 mm) bead	30' 1" (9.2 m) per cartridge

Schluter®-KERDI-BOARD-SN shower niche. It is installed in conjunction with the tile.

## Material Properties and Applications

Schluter®-SHELF is resistant to most chemicals encountered in tiled environments. In special cases, the suitability of a proposed type of material must be verified based on the anticipated chemical, mechanical, and/or other stresses. Exceptions and special considerations are listed below.

Schluter®-SHELF in **stainless steel** is produced using stainless steel 304 (1.4301 = V2A). Stainless steel can sustain high mechanical stresses and is particularly suitable for applications requiring resistance against chemicals and acids. However, even stainless steel is not resistant to all chemical stresses, and may be affected by hydrochloric and hydrofluoric acid or certain chlorine, chloride and brine concentrations, which may be present in detergents or swimming pools.

Schluter®-SHELF with **textured color-coated finishes** are produced using aluminum that is color-coated with a powder coat. The coating is color-stable, UV-resistant, and suitable for exterior use. Protect the shelf against abrasion and scratching.

## Maintenance

Schluter®-SHELF requires no special maintenance or care and is resistant to mold and fungi. Clean shelves periodically using neutral cleaning agents. Avoid the use of strong acids (e.g., hydrochloric, hydrofluoric) and bases/alkaline cleaners (e.g., bleach, ammonia, chlorides). Do not use abrasive cleaning agents and tools.

Even stainless steel requires periodic cleaning, which will maintain a neat appearance and reduce the risk of corrosion. Stainless steel surfaces develop a sheen when treated with a chrome-polishing agent.

## Shower Profiles



### 14.2 Schluter®-WS/-WSC/-WSL



### 14.2 Schluter®-WSK/-WSC/-WSL

#### Application and Function

**14.2 Schluter®-SHOWERPROFILE-WS/-WSK** system profiles, together with the Schluter®-SHOWERPROFILE-WSL/-WSC inserts, form a splashguard at the entrance of curbless showers.

Schluter®-SHOWERPROFILE-WS is an anodized aluminum support profile that is set in conjunction with the tile using thin-set mortar. It has a 3/4" (19 mm) -wide visible surface and a height of 5/16" (8 mm). Where thicker tiles are used, simply fill the space below the profile with thin-set mortar.

Schluter®-SHOWERPROFILE-WSK is an anodized aluminum support profile that is adhered to the tile surface. It has a 2-1/16" (52 mm) –wide visible surface and a height of 5/16" (8 mm).

The support profiles are combined with either the SHOWERPROFILE-WSL insert or the SHOWERPROFILE-WSC insert.

Schluter®-SHOWERPROFILE-WSL is an upright insert made of transparent polyurethane. The insert is collapsible when stepped on or rolled over with a wheelchair. The insert protrudes 1-5/32" (29 mm) above the profile surface. The SHOWERPROFILE-WSL insert does not comply with the Americans with Disabilities Act (ADA), since it exceeds the allowable height of a vertical transition despite being collapsible. Please check with local code officials for acceptance on projects where ADA guidelines must be observed before installation.

Schluter®-SHOWERPROFILE-WSC is a semi-circular insert made of semi-rigid PVC. The insert creates an inconspicuous transition from the shower area to the adjoining space and a 5/8" (16 mm) –wide visible surface. The insert protrudes 3/64" (1.2 mm) above the profile surface. The SHOWERPROFILE-WSC insert complies with the Americans with Disabilities Act (ADA).

### Material Properties and Areas of Application

The SHOWERPROFILE-WS/-WSK support profiles feature an anodized aluminum layer that retains uniform appearance during normal use. The surface, however, is susceptible to scratching and wear and may be damaged by grout or setting material. Cementitious materials, in conjunction with moisture, become alkaline. Since aluminum is sensitive to alkaline substances, exposure to the alkali (depending on the concentration and duration of exposure) may result in corrosion (aluminum hydroxide formation). Therefore, it is important to remove mortar or grout residue immediately from visible surfaces. In addition, ensure the profile is solidly embedded in the setting material and that all cavities are filled to prevent the collection of alkaline water.

The SHOWERPROFILE-WSL insert is made of highly flexible polyurethane.

The SHOWERPROFILE -WSC insert is made of semi-rigid PVC.

The inserts can withstand chemical stresses typically encountered in tiled environments.

### Maintenance

SHOWERPROFILE-WS/-WSK support profiles require no special maintenance or care and are resistant to mold and fungi. In the case of anodized aluminum, do not use abrasive cleaning agents. The SHOWERPROFILE-WSC/

-WSL inserts are specifically treated to resist the growth of fungi and bacteria and require no special maintenance or care.

### Adhesive/Sealant



### 8.3 Schluter®-KERDI-FIX

Any protrusions through the KERDI membrane can be treated with KERDI-FIX, or equivalent sealant, to ensure a fully waterproof assembly.

### Application and Function

**8.3 Schluter®-KERDI-FIX** is a single-component, waterproof sealing and bonding compound with a silane-modified polymer base, which can be used in various applications. In conjunction with KERDI, KERDI-FIX can be used to waterproof pipe and valve protrusions in the Schluter®- Shower System. KERDI-FIX is used to bond the KERDI membrane to the stainless steel KERDI-DRAIN bonding flange. KERDI-FIX can also be used to bond KERDI to building elements such as bathtubs, window elements and door frames.

### Material Properties and Areas of Application

KERDI-FIX is odorless, weather- and UV-resistant. The product is elastomeric, free of solvents, and provides a strong bond to most materials, including wood, stone, concrete, metal, glass, and many synthetic materials. KERDI-FIX can be painted over with most alkyd resins or dispersion paint types. The suitability of the material must be verified based on the anticipated chemical, mechanical, and/or other stresses. KERDI-FIX is not recommended in or around swimming pool applications.

KERDI-FIX has been evaluated according to the "Standard Method for the Testing and Evaluation of Volatile Organic Chemical Emissions from Indoor Sources Using Environmental Chambers, Version 1.1" for California Specification 01350 and found to comply with the VOC requirements. California Specification 01350 is referenced by various green building standards and rating systems.

### Maintenance

#### Storage

Unopened packages of KERDI-FIX can be stored in a cool location that is above freezing temperatures for up to 18 months.

Once the cartridge has been opened, the material has a limited shelf life.

### System Installation

For complete installation guidelines and warranty criteria for shower applications, please contact Schluter®-Systems at 800-472-4588 (USA) or 800-667-8746 (Canada) to receive a copy of the Schluter®-Shower System Installation Handbook and a step-by-step installation video. To download a PDF version of the Handbook or to view the installation video online, please visit [www.schluter.com](http://www.schluter.com).



## Product Item Numbers



## 8.3 Schluter®-KERDI-SHOWER-T

Tray with center drain placement

Item No.	Dimensions	Perimeter height	Drain placement
KST965/1525	97 cm x 152 cm (38" x 60")	29 mm (1-1/8")	center
KST1220/1525	122 cm x 152 cm (48" x 60")	28 mm (1-3/32")	center
KST1220/1830	122 cm x 183 cm (48" x 72")	32 mm (1-1/4")	center
KST1525	152 cm x 152 cm (60" x 60")	30 mm (1-3/16")	center
KST1830	183 cm x 183 cm (72" x 72")	32 mm (1-1/4")	center

## 8.3 Schluter®-KERDI-SHOWER-TS

Tray with off-center drain placement

Item No.	Dimensions	Perimeter height	Drain placement
KST965/1525S	97 cm x 152 cm (38" x 60")	29 mm (1-1/8")	off-center

## 8.3 Schluter®-KERDI-SHOWER-TT

Thin tray

Item No.	Dimensions	Perimeter height	Drain placement
KST965/810BF	81 cm x 97 cm (32" x 38")	23 mm (29/32")	center
KST915/1220BF	91 cm x 122 cm (36" x 48")	25 mm (1")	center
KST915BF	91 cm x 91 cm (36" x 36")	22 mm (7/8")	center
KST965BF	97 cm x 97 cm (38" x 38")	23 mm (29/32")	center
KST1220BF	122 cm x 122 cm (48" x 48")	25 mm (1")	center
KST965NA/BF	97 cm x 97 cm (38" x 38") <b>Neo angle</b>	26 mm (1-1/32")	off-center



## 8.8 Schluter®-KERDI-SHOWER-LT

Tray with center linear drain placement

Item No.	Dimensions	Perimeter height	Drain placement
KSLT1000	100 cm x 100 cm (39" x 39")	32 mm (1-1/4")	center
KSLT1220	122 cm x 122 cm (48" x 48")	34 mm (1-3/8")	center
KSLT1395	140 cm x 140 cm (55" x 55")	36 mm (1-7/16")	center



## 8.8 Schluter®-KERDI-SHOWER-LTS

Tray with perimeter linear drain placement

Item No.	Dimensions	Perimeter height	Drain placement
KSLT1000S	100 cm x 100 cm (39" x 39")	42 mm (1-21/32")	perimeter
KSLT1220S	122 cm x 122 cm (48" x 48")	46 mm (1-13/16")	perimeter
KSLT1395S	140 cm x 140 cm (55" x 55")	50 mm (2")	perimeter
KSLT915/1395S	91 cm x 140 cm (36" x 55")	50 mm (2")	perimeter
KSLT915/1830S	91 cm x 183 cm (36" x 72")	58 mm (2-5/16")	perimeter
KSLT965/1930S	97 cm x 193 cm (38" x 76")	60 mm (2-3/8")	perimeter
KSLT1930/965S	193 cm x 97 cm (76" x 38")	41 mm (1-5/8")	perimeter



## 8.3 Schluter®-KERDI-SHOWER-R

Prefabricated ramp

Item No.	Width	Length	Height
KSR 305/1220	48" - 122 cm	12" - 30.5 cm	1-1/4" - 32 mm



## 12.1 Schluter®-KERDI-BOARD-SC

Prefabricated curb

Item No.	Width	Length	Height
KBSC 115 150 970	4-1/2" - 11.5 cm	38" - 97 cm	6" - 15 cm
KBSC 115 150 1220	4-1/2" - 11.5 cm	48" - 122 cm	6" - 15 cm
KBSC 115 150 1524	4-1/2" - 11.5 cm	60" - 152 cm	6" - 15 cm



## 12.1 Schluter®-KERDI-BOARD-SB

Prefabricated bench

Item No.	Width	Length	Height	Shape
KBSB 410 TA	16" - 41 cm	16" - 41 cm	20" - 51 cm	Triangular
KBSB 610 TA	24" - 61 cm	24" - 61 cm	20" - 51 cm	Triangular
KBSB 290 970 RA	38" - 97 cm	11-1/2" - 29 cm	20" - 51 cm	Rectangular
KBSB 410 1220 RA	48" - 122 cm	16" - 41 cm	20" - 51 cm	Rectangular



**8.1 Schluter®-KERDI** Waterproofing membrane

Item No.	Length	Area	Thickness
Roll width: 3' 3" – 1 m			
KERDI 200/5M	16' 5" – 5 m	54 ft <sup>2</sup> – 5 m <sup>2</sup>	8 mil
KERDI 200/7M	23' – 7 m	75 ft <sup>2</sup> – 7 m <sup>2</sup>	8 mil
KERDI 200/10M	33' – 10 m	108 ft <sup>2</sup> – 10 m <sup>2</sup>	8 mil
KERDI 200/20M	65' 7" – 20 m	215 ft <sup>2</sup> – 20 m <sup>2</sup>	8 mil
KERDI 200	98' 5" – 30 m	323 ft <sup>2</sup> – 30 m <sup>2</sup>	8 mil
Roll width: 6' 7" – 2 m			
KERDI 200200	98' 5" – 30 m	646 ft <sup>2</sup> – 60 m <sup>2</sup>	8 mil
KERDI200200/15M	49' 2-1/2" – 15 m	323 ft <sup>2</sup> – 30 m <sup>2</sup>	8 mil

**8.1 Schluter®-KERDI-DS** Waterproofing membrane

Item No.	Width	Length	Area	Thickness
KERDI-DS	3' 3" – 1 m	98' 5" – 30 m	323 ft <sup>2</sup> – 30 m <sup>2</sup>	20 mil



**12.1 Schluter®-KERDI-BOARD** Waterproof building panel

Item No.	Width	Length	Thickness
KB 12 1220 812	48" – 122 cm	32" – 81 cm	1/2" – 12.5 mm
KB 5 1220 1625	48" – 122 cm	64" – 162.5 cm	3/16" – 5 mm
KB 9 1220 1625	48" – 122 cm	64" – 162.5 cm	3/8" – 9 mm
KB 12 1220 1625	48" – 122 cm	64" – 162.5 cm	1/2" – 12.5 mm
KB 5 1220 2440	48" – 122 cm	96" – 244 cm	3/16" – 5 mm
KB 9 1220 2440	48" – 122 cm	96" – 244 cm	3/8" – 9 mm
KB 12 1220 2440	48" – 122 cm	96" – 244 cm	1/2" – 12.5 mm
KB 15 1220 2440	48" – 122 cm	96" – 244 cm	5/8" – 15 mm
KB 19 625 2440	24-1/2" – 62.5 cm	96" – 244 cm	3/4" – 19 mm
KB 25 625 2440	24-1/2" – 62.5 cm	96" – 244 cm	1" – 25 mm
KB 38 625 2440	24-1/2" – 62.5 cm	96" – 244 cm	1-1/2" – 38 mm
KB 50 625 2440	24-1/2" – 62.5 cm	96" – 244 cm	2" – 50 mm
KB 15 1220 3050	48" – 122 cm	120" – 305 cm	5/8" – 15 mm



**12.1 Schluter®-KERDI-BOARD-SN** Prefabricated shower niche

Item No.	W <sub>1</sub>	H <sub>1</sub>	W <sub>2</sub>	H <sub>2</sub>	Depth
KB 12 SN 305 152 AF	12" – 305 mm	6" – 152 mm	16" – 406 mm	10" – 250 mm	3-1/2" – 8.9 cm
KB 12 SN 305 305 AF	12" – 305 mm	12" – 305 mm	16" – 406 mm	16" – 406 mm	3-1/2" – 8.9 cm
KB 12 SN 305 508 AF	12" – 305 mm	20" – 508 mm	16" – 406 mm	24" – 610 mm	3-1/2" – 8.9 cm
KB 12 SN 305 711 AF	12" – 305 mm	28" – 711 mm	16" – 406 mm	32" – 810 mm	3-1/2" – 8.9 cm

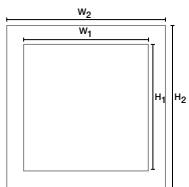



KERDI-BOARD-SNLT				Prefabricated niche with LED strip	
Item No.	Height	Width	Depth	Shelf	
KB 12 SNLT 1 WW	12" - 305 mm	12" - 305 mm	3-1/2" - 89 mm	-	
KB 12 SNLT 2 WW	20" - 508 mm	12" - 305 mm	3-1/2" - 89 mm	-	
KB 12 SNLT 3 WW	28" - 711 mm	12" - 305 mm	3-1/2" - 89 mm	1	



LIPROTEC-ECX		LED driver and dimmer		
Item No.	Input	Output	Power	
LT ECX 1W	120V AC	24V DC	60W	

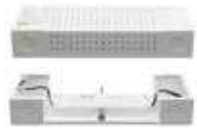

LIPROTEC-ECD		Dimmable LED driver		
Item No.	Input	Output	Power	
LT ECD 1W	120V AC	24V DC	24W	



LIPROTEC-CW		Cable for LIPROTEC white LED system		
Item No.	Length	Gauge	Conductors	
LT CW / 4M	13' 1-1/2" - 4 m	20AWG	2	
LT CW / 8M	26' 3" - 8 m	20AWG	2	
LT CW / 15M	49' 2-1/2" - 15 m	20AWG	2	





### Schluter®-KERDI-BOARD-KIT

Includes	Description	Quantity
① KERDI-BOARD	Waterproofing building panel 1/2" x 48" x 38" (1.25 cm x 122 cm x 97 cm) = <b>101 ft<sup>2</sup> (9.4 m<sup>2</sup>)</b>	8
② KERDI-BAND	Waterproofing strip 5" x 98' 5" (125 mm x 30 m)	1
③ KERDI-SEAL-PS	Pipe seal 1/2" (12.5 mm), 3/4" (20 mm)	2
④ KERDI-SEAL-MV	Mixing valve seal 4-1/2" (114 mm)	1
⑤ KERDI-BOARD-ZT/-ZS	Screws and washers	140
⑥ KERDI-FIX	Sealant 9.8 fl oz (290 ml)	2



#### 8.1 Schluter®-KERDI-BAND

#### Waterproofing strip

Item No.	Width	Length	Thickness
KEBA 100/125/5M	5" – 12.5 cm	16' 5" – 5 m	4 mil
KEBA 100/125/10M	5" – 12.5 cm	33' – 10 m	4 mil
KEBA 100/125	5" – 12.5 cm	98' 5" – 30 m	4 mil
KEBA 100/125/300	5" – 12.5 cm	984' 3" – 300 m	4 mil
KEBA 100/185/5M	7-1/4" – 18.5 cm	16' 5" – 5 m	4 mil
KEBA 100/185	7-1/4" – 18.5 cm	98' 5" – 30 m	4 mil
KEBA 100/250/5M	10" – 25 cm	16' 5" – 5 m	4 mil
KEBA 100/250	10" – 25 cm	98' 5" – 30 m	4 mil



#### 8.1 Schluter®-KERDI-FLEX

#### Waterproofing strip for use above movement joints

Item No.	Width	Length	Thickness
FLEX 125/5M	5" – 12.5 cm	16' 5" – 5 m	12 mil
FLEX 250/5M	10" – 25 cm	16' 5" – 5 m	12 mil
FLEX 125/30	5" – 12.5 cm	98' 5" – 30 m	12 mil
FLEX 250/30	10" – 25 cm	98' 5" – 30 m	12 mil



#### 8.1 Schluter®-KERDI-KERECK-F

#### Preformed corner

Item No.	Thickness	Packaging
KERECK/FI 2	4 mil	2 inside corners
KERECK/FI 10	4 mil	10 inside corners
KERECK/FA 2	4 mil	2 outside corners
KERECK/FA 10	4 mil	10 outside corners



#### 8.1 Schluter®-KERDI-KERS-B

#### Preformed corner

Item No.	Thickness	Description	Packaging
KERECK 135 FI 2	4 mil	Inside corner, 135°	2 units
KERECK 135 FI 10	4 mil	Inside corner, 135°	10 units
KERSB 135 K LR	4 mil	Bench corners	1 right and 1 left
KERSB 135 K 5LR	4 mil	Bench corners	5 right and 5 left
KERSB 135 K	4 mil	Bench/ neo-angle corner kit	1 right and 1 left bench corner, and 2 135° inside corners



#### 8.3 Schluter®-KERDI-FIX

#### Adhesive/sealant

Item No.	Description
KERDIFIX / <i>color</i> *	Cartridge - 9.81 fl oz – 290 ml
KERDIFIX 100 G	Tube - 3.38 fl oz – 100 ml

#### \*Color Codes



To complete the item number, add the *color* code (e.g., KERDIFIX/BW).



### 8.1 Schluter®-KERDI-KERS

Preformed corner

Item No.	Thickness	Packaging
KERS 20L	4 mil	Left inside corner – 3/4" (20 mm)
KERS 28L	4 mil	Left inside corner – 1-3/32" (28 mm)
KERS 20R	4 mil	Right inside corner – 3/4" (20 mm)
KERS 28R	4 mil	Right inside corner – 1-3/32" (28 mm)



### 8.1 Schluter®-KERDI-SEAL-PS

Pipe seal with over-molded rubber gasket

Item No.	Pipe nipple opening diam.	Thickness	Packaging
KMS185/12	1/2" – 12.5 cm	4 mil	1 unit
KMS185/20	3/4" – 20 cm	4 mil	1 unit
KMS10185/12	1/2" – 12.5 cm	4 mil	10 units
KMS10185/20	3/4" – 20 cm	4 mil	10 units



### 8.1 Schluter®-KERDI-SEAL-MV

Mixing valve seal with over-molded rubber gasket

Item No.	Mixing valve opening diam.	Thickness	Packaging
KMSMV235/114	4-1/2" – 114 cm	4 mil	1 unit
KMSMV10235/114	4-1/2" – 114 cm	4 mil	10 units



### 8.1 Schluter®-KERDI-KM

Pipe seal

Item No.	Dimensions	Thickness	Packaging
KM5117/22	7" x 7" – 17 x 17 cm	4 mil	5 units

Hole diameter,  $\phi = 7/8" - 22 \text{ mm}$ 

### 14.2 Schluter®-SHOWERPROFILE-WS

Support profile

Item No.	Height	Length
SPWS 19 AE/100	5/16" - 8 mm	39" - 1 m
SPWS 19 AE	5/16" - 8 mm	8' 2-1/2" - 2.5 m



### 14.2 Schluter®-SHOWERPROFILE-WSK

Support profile - retrofit

Item No.	Height	Length
SPWSK 52 AE/100	5/16" - 8 mm	39" - 1 m
SPWSK 52 AE	5/16" - 8 mm	8' 2-1/2" - 2.5 m



### 14.2 Schluter®-SHOWERPROFILE-WSC

Semi-circular lip insert

Item No.	Height	Length
SPWSC 16 GS/100	5/16" - 8 mm	39" - 1 m
SPWSC 16 GS	5/16" - 8 mm	8' 2-1/2" - 2.5 m



### 14.2 Schluter®-SHOWERPROFILE-WSL

Straight lip insert

Item No.	Height	Length
SPWSL 30 T/100	5/16" - 8 mm	39" - 1 m
SPWSL 30 T	5/16" - 8 mm	8' 2-1/2" - 2.5 m



### 14.2 Schluter®-SHOWERPROFILE-WSK-EK

End cap

Item No.	Height
EK/SPWSK 52 AE	5/16" - 8 mm

### Schluter®-KERDI-TROWEL

Trowel



Item No.	Notch Size	Packaging
TRL-KER6	1/8" x 1/8" - 3 x 3 mm	6 units
TRL-KER	1/8" x 1/8" - 3 x 3 mm	1 unit







8.2 Schluter®-KERDI-DRAIN



4" Grate Options

Tileable Covering Support	Anodized Aluminum		
 <p><b>TILE (ECS)</b> Patent pending</p>	 <p>Available in the following colors and finishes:</p> <div style="display: flex; justify-content: space-around;"> <div data-bbox="609 735 755 819"> <p>Brushed Nickel (ATGB)</p> </div> <div data-bbox="779 735 925 819"> <p>Brushed Copper (AKGB)</p> </div> <div data-bbox="950 735 1096 819"> <p>Brushed Brass (AMGB)</p> </div> </div> <p><b>CONTOUR</b></p>		

Stainless Steel

 <p>Available in the following colors and finishes:</p> <div style="display: grid; grid-template-columns: repeat(2, 1fr); gap: 5px;"> <div data-bbox="259 1008 406 1092"> <p>Stainless Steel (E)</p> </div> <div data-bbox="430 1008 576 1092"> <p>Rose Gold (ERG)</p> </div> <div data-bbox="259 1113 406 1197"> <p>Chrome (EP)</p> </div> <div data-bbox="430 1113 576 1197"> <p>Vintage Gold (EVG)</p> </div> <div data-bbox="259 1218 406 1302"> <p>Oil-rubbed Bronze (EOB)</p> </div> <div data-bbox="430 1218 576 1302"> <p>Classic Gold (ECG)</p> </div> <div data-bbox="259 1323 406 1386"> <p>Nickel (ET)</p> </div> </div> <p><b>CLASSIC</b></p>	 <p><b>PURE</b></p>  <p><b>CURVE</b></p>  <p><b>FLORAL</b></p> <p>Available in the following colors and finishes:</p> <div style="display: grid; grid-template-columns: repeat(4, 1fr); gap: 5px;"> <div data-bbox="933 1008 1079 1092"> <p>Brushed Stainless Steel (EB)</p> </div> <div data-bbox="1104 1008 1250 1092"> <p>Brushed Nickel (EBT)</p> </div> <div data-bbox="1274 1008 1421 1092"> <p>Brushed Rose Gold (EBRG)</p> </div> <div data-bbox="1445 1008 1591 1092"> <p>Brushed Vintage Gold (EBVG)</p> </div> <div data-bbox="933 1113 1079 1197"> <p>Brushed Classic Gold (EBCG)</p> </div> <div data-bbox="1104 1113 1250 1197"> <p>Matte White (MBW)</p> </div> <div data-bbox="1274 1113 1421 1197"> <p>Ivory (TSI)</p> </div> <div data-bbox="1445 1113 1591 1197"> <p>Greige (TSBG)</p> </div> <div data-bbox="933 1218 1079 1302"> <p>Cream (TSC)</p> </div> <div data-bbox="1104 1218 1250 1302"> <p>Bronze (TSOB)</p> </div> <div data-bbox="1274 1218 1421 1302"> <p>Stone Grey (TSSG)</p> </div> <div data-bbox="1445 1218 1591 1302"> <p>Pewter (TSG)</p> </div> <div data-bbox="933 1323 1079 1386"> <p>Dark Anthracite (TSDA)</p> </div> <div data-bbox="1104 1323 1250 1386"> <p>Matte Black (MGS)</p> </div> </div>
--	---

6" Grate Options

Stainless Steel	Stainless Steel Cover for Cleanout Applications
 <p><b>CLASSIC (6E)</b></p>  <p><b>CLASSIC ROUND (6E)</b></p>	 <p><b>(6CE)</b></p>

Flange Options

ABS - 2" or 3" Outlet	PVC - 2" or 3" Outlet	Stainless Steel - 2" or 3" No-hub Outlet	Stainless Steel - 2" Threaded Outlet
			





Note: Product listings and certifications can be referenced on page 43.





Schluter®-KERDI-DRAIN

**ABS or PVC FLANGE — 2" or 3" OUTLET**

2" (50 mm) drain outlet		3" (75 mm) drain outlet	
Material	Item No.	Material	Item No.
 ABS	KD2 FLK ABS	 ABS	KD3 FLK ABS
 PVC	KD2 FLK PVC	 PVC	KD3 FLK PVC

Additional components included			
 <b>4x</b> Inside corners	 <b>2x</b> Outside corners	 <b>1x</b> Pipe seal (3/4" - 20 mm)	 <b>1x</b> Mixing valve seal (4-1/2" - 114 mm)

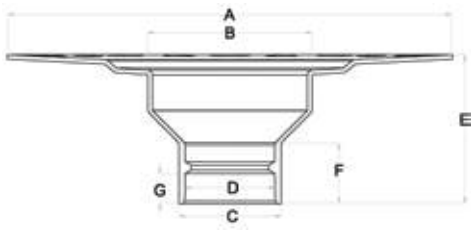
Flange measurements			
ABS or PVC			
		2" (50 mm) drain outlet	3" (75 mm) drain outlet
	A	11-13/16" - 300 mm	11-13/16" - 300 mm
	B	4-17/32" - 115.2 mm	4-17/32" - 115.2 mm
	C	2-45/64" - 68.6 mm	3-15/16" - 100 mm
	D	2-3/8" - 60.5 mm	3-1/2" - 88.8 mm
	E	3-15/16" - 100 mm	3-15/16" - 100 mm
	F	1-39/64" - 40.6 mm	2" - 50.8 mm
	G	7/8" - 22.5 mm	1-1/2" - 38.1 mm





When using a flange with 3" outlet, a 6" grate is recommended.

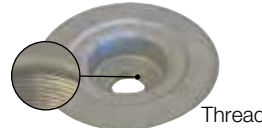

Schluter®-KERDI-DRAIN

**STAINLESS STEEL FLANGE – 2" or 3" OUTLET**

2" (50 mm) drain outlet	
Material	Item No.
 <p>No-hub</p>	KD2 FLK E
 <p>Threaded</p>	KD2 FLK ETH

3" (75 mm) drain outlet	
Material	Item No.
 <p>No-hub</p>	KD3 FLK E

Additional components included					
 <p><b>4x</b> Inside corners</p>	 <p><b>2x</b> Outside corners</p>	 <p><b>1x</b> Pipe seal (3/4" - 20 mm)</p>	 <p><b>1x</b> Mixing valve seal (4-1/2" - 114 mm)</p>	 <p><b>1x</b> KERDI-FIX sealing and bonding compound (3.38 fl oz - 100 ml)</p>	

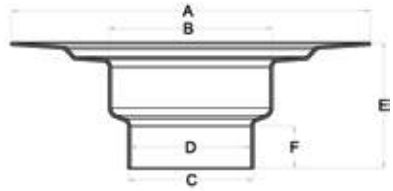
Flange measurements			
Stainless steel			
		2" (50 mm) no-hub outlet	3" (75 mm) no-hub outlet
	A	9-27/32" - 250 mm	9-27/32" - 250 mm
	B	4-1/2" - 115.4 mm	4-1/2" - 114 mm
	C	2-13/32" - 61.3 mm	3-7/16" - 87.4 mm
	D	2-13/32" - 60.6 mm	3-5/16" - 84.2 mm
	E	3-11/32" - 85 mm	3-7/16" - 87.4 mm
	F	53/64" - 21 mm	1-5/32" - 29.4 mm



When using a flange with 3" outlet, a 6" grate is recommended.

Schluter®-KERDI-DRAIN-H

ABS or PVC FLANGE — 2" OUTLET HORIZONTAL

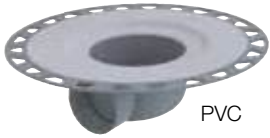
2" (50 mm) drain outlet	
Material	Item No.
 ABS	KDH2 FLK ABS
 PVC	KDH2 FLK PVC

Additional components included

 <b>4x</b> Inside corners	 <b>2x</b> Outside corners	 <b>1x</b> Pipe seal (3/4" - 20 mm)	 <b>1x</b> Mixing valve seal (4-1/2" - 114 mm)
--	--	--	---

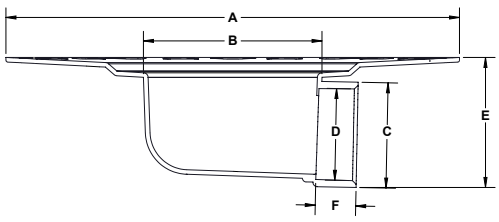
Flange measurements		
ABS or PVC		
	<b>2" (50 mm) horizontal drain outlet</b>	
	A	11-13/16" - 300 mm
	B	4-21/32" - 118.3 mm
	C	2-47/64" - 69.5 mm
	D	2-3/8" - 60.5 mm
	E	3-3/8" - 85.7 mm
	F	1-1/16" - 27 mm

Schluter®-KERDI-SHOWER-CB

**Schluter®-KERDI-SHOWER-CB** is a height compensation board made of lightweight expanded polystyrene used to accommodate the drain body and waste pipe height, when installing the Schluter®-KERDI-DRAIN-H in conjunction with the Schluter®-KERDI-SHOWER -T/TS/TT shower trays. The compensation board can easily be cut to size to fit around the drain and waste pipe, and multiple boards can be used to fit the size and shape of the shower.

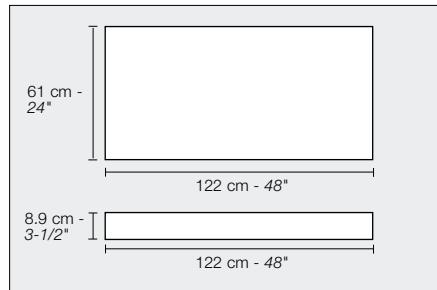

Schluter®-KERDI-SHOWER-CB	
Compensation board	
Item No.	Dimensions
KSCB 90 610 1220	122 cm x 61 cm x 8.9 cm (48" x 24" x 3-1/2")



Schluter®-KERDI-DRAIN-A

**ADAPTOR KIT — 5-1/4" or 7-1/2" ADAPTOR RING**

Schluter®-KERDI-DRAIN adaptor kits are designed to convert clamping ring drains to integrated bonding flange drains when removal of the clamping ring drain is not practical (e.g., when they are set in concrete slabs). The adaptor kit includes a stainless steel adaptor ring, available in 5-1/4" (133 mm) and 7-1/2" (191 mm) diameter sizes, with an over-molded rubber gasket and a variety of perforated hole patterns that align with most common clamping ring drains.

5-1/4" (133.4 mm) adaptor ring	
Flange and ring	Item No.
<p>5-1/4"</p> <p><b>Also included:</b> Height adjustment collar for KERDI-DRAIN grate</p>	KDA5 FLK ABS

7-1/2" (191 mm) adaptor ring	
Flange and ring	Item No.
<p>7-1/2"</p> <p><b>Also included:</b> Lateral adjustment ring for KERDI-DRAIN grate</p>	KDA7 FLK ABS

**Additional components included**

	<b>4x</b> Inside corners		<b>2x</b> Outside corners		<b>1x</b> Pipe seal (3/4" - 20 mm)		<b>1x</b> Mixing valve seal (4-1/2" - 114 mm)		<b>1x</b> KERDI-FIX sealing and bonding compound (3.38 fl oz - 100 ml)
--	-----------------------------	--	------------------------------	--	---------------------------------------	--	--	--	---

Flange and adaptor ring measurements	
ABS	
	5-1/4"
	A 11-13/16" - 300 mm
	B 2-13/32" - 60.7 mm
	C 2-23/32" - 69.3 mm
	D 5-1/4" - 133.4 mm
	E 2-29/32" - 74 mm
	F 1-1/64" - 25.9 mm
	G 2-1/16" - 52.6 mm

Flange and adaptor ring measurements	
ABS	
	7-1/2"
	A 11-13/16" - 300 mm
	B 4-13/32" - 111.8 mm
	C 4-11/16" - 118.9 mm
	D 7-1/2" - 191 mm
	E 5-7/64" - 130 mm
	F 3-1/16" - 77.8 mm
	G 3-41/64" - 92.4 mm



The tileable grate and the 6" round/square grates are **NOT** compatible with the 5-1/4" ring flange.

Schluter®-KERDI-DRAIN-STYLE

**GRATES FOR USE WITH FLANGES WITH 2" OUTLET**

**4" (100 mm) Grate**

**Stainless Steel**

PURE	
Grate finish	Item No.
Brushed stainless steel (EB)	KDIF4 GRK EB D8
Brushed nickel (EBT)	KDIF4 GRK EBT D8
Brushed rose gold (EBRG)	KDIF4 GRK EBRG D8
Brushed vintage gold (EBVG)	KDIF4 GRK EBVG D8
Brushed classic gold (EBCG)	KDIF4 GRK EBCG D8



U.S. Patent No. D831,795

CURVE	
Grate finish	Item No.
Brushed stainless steel (EB)	KDIF4 GRK EB D6
Brushed nickel (EBT)	KDIF4 GRK EBT D6
Brushed rose gold (EBRG)	KDIF4 GRK EBRG D6
Brushed vintage gold (EBVG)	KDIF4 GRK EBVG D6
Brushed classic gold (EBCG)	KDIF4 GRK EBCG D6



U.S. Patent No. D831,171

FLORAL	
Grate finish	Item No.
Brushed stainless steel (EB)	KDIF4 GRK EB D5
Brushed nickel (EBT)	KDIF4 GRK EBT D5
Brushed rose gold (EBRG)	KDIF4 GRK EBRG D5
Brushed vintage gold (EBVG)	KDIF4 GRK EBVG D5
Brushed classic gold (EBCG)	KDIF4 GRK EBCG D5



U.S. Patent No. D831,172

Contents					
	<b>1x</b> Grate and frame		<b>1x</b> Height adjustment collar		<b>1x</b> Lateral adjustment ring



Schluter®-KERDI-DRAIN-STYLE

**GRATES FOR USE WITH FLANGES WITH 2" OUTLET**

**4" (100 mm) Grate**

**TRENDLINE**

PURE	
Grate finish	Item No.
Matte white (MBW)	KDIF4 GRK MBW D8
Ivory (TSI)	KDIF4 GRK TSI D8
Greige (TSBG)	KDIF4 GRK TSBG D8
Cream (TSC)	KDIF4 GRK TSC D8
Bronze (TSOB)	KDIF4 GRK TSOB D8
Stone grey (TSSG)	KDIF4 GRK TSSG D8
Pewter (TSG)	KDIF4 GRK TSG D8
Dark anthracite (TSDA)	KDIF4 GRK TSDA D8
Matte black (MGS)	KDIF4 GRK MGS D8

U.S. Patent No. D831,795

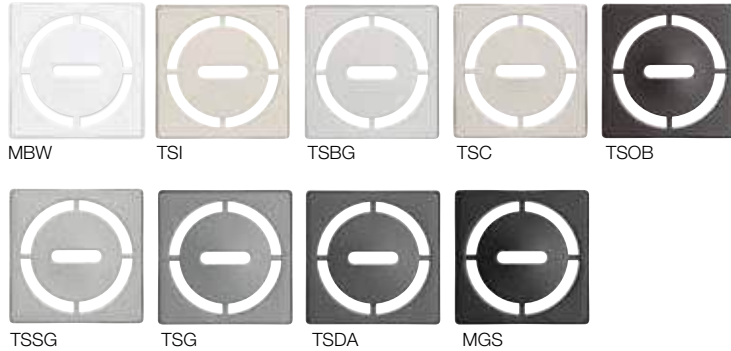

CURVE	
Grate finish	Item No.
Matte white (MBW)	KDIF4 GRK MBW D6
Ivory (TSI)	KDIF4 GRK TSI D6
Greige (TSBG)	KDIF4 GRK TSBG D6
Cream (TSC)	KDIF4 GRK TSC D6
Bronze (TSOB)	KDIF4 GRK TSOB D6
Stone grey (TSSG)	KDIF4 GRK TSSG D6
Pewter (TSG)	KDIF4 GRK TSG D6
Dark anthracite (TSDA)	KDIF4 GRK TSDA D6
Matte black (MGS)	KDIF4 GRK MGS D6

U.S. Patent No. D831,171



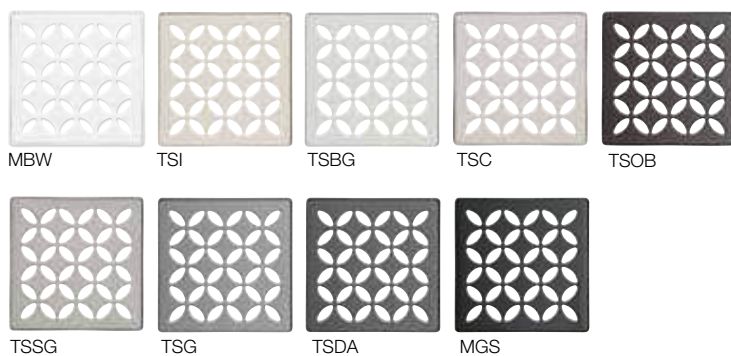

FLORAL	
Grate finish	Item No.
Matte white (MBW)	KDIF4 GRK MBW D5
Ivory (TSI)	KDIF4 GRK TSI D5
Greige (TSBG)	KDIF4 GRK TSBG D5
Cream (TSC)	KDIF4 GRK TSC D5
Bronze (TSOB)	KDIF4 GRK TSOB D5
Stone grey (TSSG)	KDIF4 GRK TSSG D5
Pewter (TSG)	KDIF4 GRK TSG D5
Dark anthracite (TSDA)	KDIF4 GRK TSDA D5
Matte black (MGS)	KDIF4 GRK MGS D5

U.S. Patent No. D831,172



**Contents**

 <p><b>1x</b> Grate and frame</p>	 <p><b>1x</b> Height adjustment collar</p>	 <p><b>1x</b> Lateral adjustment ring</p>
---	---	--





Schluter®-KERDI-DRAIN

GRATES FOR USE WITH FLANGES WITH 2" OUTLET

4" (100 mm) Grate

Stainless steel - CLASSIC

CLASSIC	
Grate finish	Item No.
Stainless steel (E)	KD4 GRK E
Chrome (EP)	KD4 GRK EP
Oil-rubbed bronze (EOB)	KD4 GRK EOB
Nickel (ET)	KD4 GRK ET
Rose gold (ERG)	KD4 GRK ERG
Vintage gold (EVG)	KD4 GRK EVG
Classic gold (ECG)	KD4 GRK ECG



Anodized aluminum - CONTOUR

CONTOUR	
Grate finish	Item No.
Brushed nickel (ATGB)	KD4 GRK ATGB
Brushed copper (AKGB)	KD4 GRK AKGB
Brushed brass (AMGB)	KD4 GRK AMGB



Contents



**1x**  
Grate and frame



**1x**  
Height adjustment collar



**1x**  
Lateral adjustment ring

Schluter®-KERDI-DRAIN

**GRATES FOR USE WITH FLANGES WITH 2" OUTLET**

**4" (100 mm) Grate**

TILE

TILE	
Grate finish	Item No.
TILE	KD4 GRK ECS



Contents	
	<b>1x</b> Tileable covering support
	<b>1x</b> Spacer
	<b>1x</b> Lateral adjustment ring



The tileable grate is not suitable for use with the KERDI-DRAIN-F flange and the KERDI-DRAIN-A flange with 5-1/4" (133.4 mm) adaptor ring.



**GRATES FOR USE WITH FLANGES WITH 2" or 3" OUTLET**

**6" (150 mm) Grate**

Stainless steel - CLASSIC

CLASSIC SQUARE	
Grate finish	Item No.
Stainless steel (E)	KD6 GRK E



Contents	
	<b>1x</b> Grate and frame with integrated height adjustment collar
	<b>1x</b> Lateral adjustment ring

CLASSIC ROUND	
Grate finish	Item No.
Stainless steel (E)	KD6 GRK RE











The 6" (150 mm) grates are not suitable for use with the KERDI-DRAIN-F flange and the KERDI-DRAIN-A flange with 5-1/4" (133.4 mm) adaptor ring.



Schluter®-KERDI-DRAIN









**DRAIN KITS — ABS or PVC FLANGE - 2" OUTLET - STAINLESS STEEL GRATE**

Schluter®-KERDI-DRAIN		
	ABS - 2" (50 mm)	PVC - 2" (50 mm)
4" (100 mm) square grate		
Stainless steel	KD2/ABS/E	KD2/PVC/E

Contents							
	<b>1x</b> Flange		<b>1x</b> Grate and frame		<b>1x</b> Height adjustment collar		<b>1x</b> Lateral adjustment ring
	<b>4x</b> Inside corners		<b>2x</b> Outside corners		<b>1x</b> Pipe seal (3/4" - 20 mm)		<b>1x</b> Mixing valve seal (4-1/2" - 114 mm)



**ADAPTOR KIT — 5-1/4" ADAPTOR RING - 4" STAINLESS STEEL GRATE**



5-1/4" (133.4 mm) adaptor ring	
	ABS
4" (100 mm) square grate	
Stainless steel	KDAR/ABS/E

Contents							
	<b>1x</b> Flange		<b>1x</b> Grate and frame		<b>1x</b> Height adjustment collar		<b>1x</b> Adaptor ring
	<b>4x</b> Inside corners		<b>2x</b> Outside corners		<b>1x</b> Pipe seal (3/4" - 20 mm)		<b>1x</b> Mixing valve seal (4-1/2" - 114 mm)
	<b>1x</b> KERDI-FIX sealing and bonding compound (3.38 fl oz - 100 ml)						



Schluter®-KERDI-DRAIN

**ABS or PVC FLANGE — 2" or 3" OUTLET - WITHOUT SEALS AND CORNERS**

2" (50 mm) drain outlet		
Material	1 Unit	10 Units
	Item No.	Item No.
 ABS	KD2/ABS/FL	KD2/ABS/FL10
 PVC	KD2/PVC/FL	KD2/PVC/FL10

3" (75 mm) drain outlet	
Material	Item No.
 ABS	KD3/ABS/FL
 PVC	KD3/PVC/FL

**ABS or PVC HORIZONTAL FLANGE — 2" OUTLET - WITHOUT SEALS AND CORNERS**

2" (50 mm) drain outlet	
Material	Item No.
 ABS	KDH2/ABS/FL
 PVC	KDH2/PVC/FL

**STAINLESS STEEL FLANGE — 2" or 3" OUTLET - WITHOUT SEALS AND CORNERS**

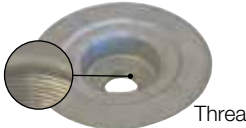
2" (50 mm) drain outlet		
Material	1 Unit	10 Units
	Item No.	Item No.
 No-hub	KD2/E/FL	KD2/E/FL10
 Threaded	KD2/ETH/FL	-

3" (75 mm) drain outlet	
Material	Item No.
 No-hub	KD3/E/FL

Also included with stainless steel flanges



**1x**  
KERDI-FIX  
sealing and bonding compound  
(3.38 fl oz – 100 ml)

Note: Not included with 10-pack









When using a flange with 3" outlet, a 6" grate is recommended.



Schluter®-KERDI-DRAIN

10 PACKS — ABS OR PVC FLANGE - 2" OUTLET





2" (50 mm) drain outlet	
Material	Item No.
 ABS	KD2 FLK ABS 10
 PVC	KD2 FLK PVC 10

Additional components included	
 <b>40x</b> Inside corners	 <b>20x</b> Outside corners
 <b>10x</b> Pipe seal (3/4" - 20 mm)	 <b>10x</b> Mixing valve seal (4-1/2" - 114 mm)

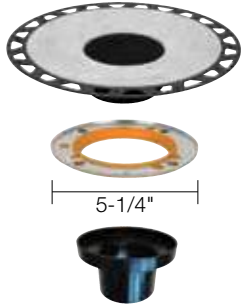
Note: 10 packs are packaged in bulk, not individually boxed.

10 PACKS — ABS FLANGE - 5-1/4" ADAPTOR RING

5-1/4" (133.4 mm) adaptor ring	
Flange and ring	Item No.
 5-1/4" <b>Also included:</b> Height adjustment collar for KERDI-DRAIN grate	KDA5 FLK ABS 10

Additional components included	
 <b>40x</b> Inside corners	 <b>20x</b> Outside corners
 <b>10x</b> Pipe seal (3/4" - 20 mm)	 <b>10x</b> Mixing valve seal (4-1/2" - 114 mm)
 <b>10x</b> KERDI-FIX sealing and bonding compound (3.38 fl oz - 100 ml)	

Note: 10 packs are packaged in bulk, not individually boxed.





The tileable grate and the 6" round/square grates are **NOT** compatible with the 5-1/4" ring flange.

10 PACKS — 4" GRATE - STAINLESS STEEL

Stainless steel - CLASSIC



Stainless steel
Item No.
KD4 GRK E 10

Contents	
 <b>10x</b> Grate and frame	 <b>10x</b> Height adjustment collar
 <b>10x</b> Lateral adjustment ring	

Note: 10 packs are packaged in bulk, not individually boxed.

## Schluter®-KERDI-DRAIN

### 6" SQUARE CLEAN OUT COVER

The **Schluter®-KERDI-DRAIN Clean Out Cover** is a 6" stainless steel cover available for installations where the KERDI-DRAIN bonding flange is to be used in a cleanout application.



Clean out cover 6"	
Item No.	Finish
KD-GR6C-E	Stainless steel

### TAMPER PROOF SCREWS

**Schluter®-KERDI-DRAIN Tamper Proof Screws** are designed as a high security accessory for the KERDI-DRAIN. Ideal for loss prevention and anti-theft, these tamper proof screws are used in environments where tamper resistance is desired or required (e.g., healthcare or education facilities, etc.). Phillips head screws are included with the KERDI-DRAIN. The tamper-proof screws as well as the driver bit must be purchased separately.



Tamper proof screw and driver bit	
Item No.	Description
KD/TPSCRW	Tamper proof screw
KD/TPWRCH	Driver bit

### STRAINER

The **Schluter®-KERDI-DRAIN Strainer** is a hair catcher customized to fit inside the KERDI-DRAIN flange to trap and collect hair. Simple to remove and clean, the hair catcher fits discreetly into the drain to prevent hair clogs that can lead to blocked pipes.

**Note:** The KERDI-DRAIN strainer is only suitable for use with flanges with 2" (50 mm) vertical outlets (ABS, PVC, and stainless steel with no-hub or threaded outlet).



Strainer for KERDI-DRAIN	
Item No.	Description
KD-STR	Strainer



**Note:** There are multiple selections to be made for this product. Begin by selecting the appropriate channel body length then proceed to grate selection accordingly, keeping in mind there two frame height options for the SOLID (A) and SQUARE (B) grates.

Schluter®-KERDI-LINE

**CHANNEL BODY**

**Contents**

- 1x** Channel body
- 1x** Channel support
- 1x** No-hub coupling
- 4x** Inside corners
- 2x** Outside corners
- 1x** Pipe seal (3/4" - 20 mm)
- 1x** Mixing valve seal (4-1/2" - 114 mm)

Channel body center outlet

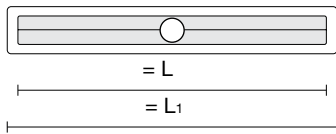

Schluter®-KERDI-LINE		
Channel body - stainless steel - center outlet		
L = in. - cm	L1 = in. - cm	Item No.
19-11/16 - 50	21-11/16 - 55	KL1V 60 E 50
23-5/8 - 60	25-5/8 - 65	KL1V 60 E 60
27-9/16 - 70	29-9/16 - 75	KL1V 60 E 70
31-1/2 - 80	33-1/2 - 85	KL1V 60 E 80
35-7/16 - 90	37-7/16 - 95	KL1V 60 E 90
39-3/8 - 100	41-3/8 - 105	KL1V 60 E 100
43-5/16 - 110	45-5/16 - 115	KL1V 60 E 110
47-1/4 - 120	49-1/4 - 125	KL1V 60 E 120
51-3/16 - 130	53-3/16 - 135	KL1V 60 E 130
55-1/8 - 140	57-1/8 - 145	KL1V 60 E 140
59-1/16 - 150	61-1/16 - 155	KL1V 60 E 150
62-15/16 - 160	64-15/16 - 165	KL1V 60 E 160
66-7/8 - 170	68-7/8 - 175	KL1V 60 E 170
70-13/16 - 180	72-13/16 - 185	KL1V 60 E 180

Channel body off-set outlet

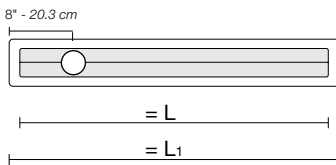

Channel body - stainless steel - off-set outlet		
L = in. - cm	L1 = in. - cm	Item No.
27-9/16 - 70	29-9/16 - 75	KL1VO 60 E 70
31-1/2 - 80	33-1/2 - 85	KL1VO 60 E 80
35-7/16 - 90	37-7/16 - 95	KL1VO 60 E 90
39-3/8 - 100	41-3/8 - 105	KL1VO 60 E 100
43-5/16 - 110	45-5/16 - 115	KL1VO 60 E 110
47-1/4 - 120	49-1/4 - 125	KL1VO 60 E 120



Schluter®-KERDI-LINE

GRATE ASSEMBLY - BRUSHED STAINLESS STEEL

CONTENTS

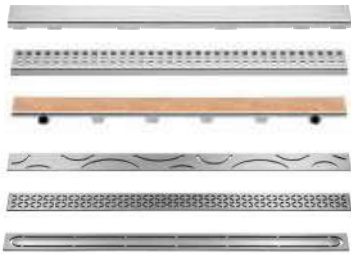

**1x**

- Grate  
6 design options:
- SOLID
  - SQUARE
  - TILE
  - CURVE
  - FLORAL
  - PURE



**1x**

Grate frame with height adjustment spacers.  
See product tables for frame height options (not included with TILE grate).



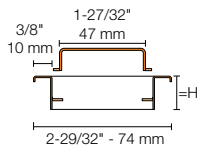

SOLID (A)

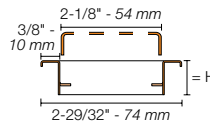

SQUARE (B)



Grate assemblies - Brushed stainless steel

Length = in. - cm	SOLID (A)	SQUARE (B)
	Item No.	Item No.
 3/4" (19 mm) frame height for 1/8" to 9/16" (3 mm to 15 mm) -thick coverings		
19-11/16 - 50	KL1AR 19 EB 50	KL1B 19 EB 50
23-5/8 - 60	KL1AR 19 EB 60	KL1B 19 EB 60
27-9/16 - 70	KL1AR 19 EB 70	KL1B 19 EB 70
31-1/2 - 80	KL1AR 19 EB 80	KL1B 19 EB 80
35-7/16 - 90	KL1AR 19 EB 90	KL1B 19 EB 90
39-3/8 - 100	KL1AR 19 EB 100	KL1B 19 EB 100
43-5/16 - 110	KL1AR 19 EB 110	KL1B 19 EB 110
47-1/4 - 120	KL1AR 19 EB 120	KL1B 19 EB 120
51-3/16 - 130	KL1AR 19 EB 130	KL1B 19 EB 130
55-1/8 - 140	KL1AR 19 EB 140	KL1B 19 EB 140
59-1/16 - 150	KL1AR 19 EB 150	KL1B 19 EB 150
62-15/16 - 160	KL1AR 19 EB 160	KL1B 19 EB 160
66-7/8 - 170	KL1AR 19 EB 170	KL1B 19 EB 170
70-13/16 - 180	KL1AR 19 EB 180	KL1B 19 EB 180
 1-1/8" (30 mm) frame height for 1/2" to 1" - (13 mm to 25 mm) -thick coverings		
19-11/16 - 50	KL1AR 30 EB 50	KL1B 30 EB 50
23-5/8 - 60	KL1AR 30 EB 60	KL1B 30 EB 60
27-9/16 - 70	KL1AR 30 EB 70	KL1B 30 EB 70
31-1/2 - 80	KL1AR 30 EB 80	KL1B 30 EB 80
35-7/16 - 90	KL1AR 30 EB 90	KL1B 30 EB 90
39-3/8 - 100	KL1AR 30 EB 100	KL1B 30 EB 100
43-5/16 - 110	KL1AR 30 EB 110	KL1B 30 EB 110
47-1/4 - 120	KL1AR 30 EB 120	KL1B 30 EB 120





Schluter®-KERDI-LINE

GRATE ASSEMBLY - CHROME

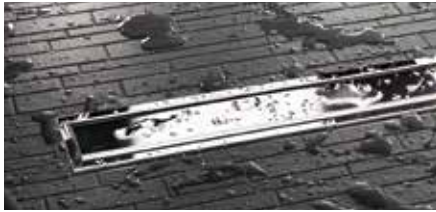

SOLID (A)

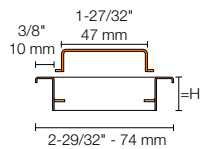

SQUARE (B)

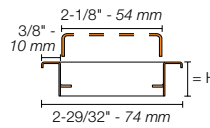

Grate assemblies - Chrome			
3/4" (19 mm) frame height for 1/8" to 9/16" (3 mm to 15 mm) -thick coverings			
Length = in. - cm	SOLID (A)		SQUARE (B)
	Item No.		Item No.
19-11/16 - 50	KL1AR 19 EP 50	KL1B 19 EP 50	
23-5/8 - 60	KL1AR 19 EP 60	KL1B 19 EP 60	
27-9/16 - 70	KL1AR 19 EP 70	KL1B 19 EP 70	
31-1/2 - 80	KL1AR 19 EP 80	KL1B 19 EP 80	
35-7/16 - 90	KL1AR 19 EP 90	KL1B 19 EP 90	
39-3/8 - 100	KL1AR 19 EP 100	KL1B 19 EP 100	
43-5/16 - 110	KL1AR 19 EP 110	KL1B 19 EP 110	
47-1/4 - 120	KL1AR 19 EP 120	KL1B 19 EP 120	

GRATE ASSEMBLY - FRAMELESS TILEABLE



TILE (D)

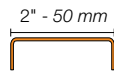

Grate assemblies - Frameless tileable			
Length = in. - cm	Item No.		
	TILE (D)		
	For use with center outlet channel body	For use with off-set outlet channel body	
19-11/16 - 50	KL1DRE 50	-	
23-5/8 - 60	KL1DRE 60	-	
27-9/16 - 70	KL1DRE 70	KL1DRO E 70	
31-1/2 - 80	KL1DRE 80	KL1DRO E 80	
35-7/16 - 90	KL1DRE 90	KL1DRO E 90	
39-3/8 - 100	KL1DRE 100	KL1DRO E 100	
43-5/16 - 110	KL1DRE 110	KL1DRO E 110	
47-1/4 - 120	KL1DRE 120	KL1DRO E 120	
51-3/16 - 130	KL1DRE 130	-	
55-1/8 - 140	KL1DRE 140	-	
59-1/16 - 150	KL1DRE 150	-	
62-15/16 - 160	KL1DRE 160	-	
66-7/8 - 170	KL1DRE 170	-	
70-13/16 - 180	KL1DRE 180	-	

**GRATE ASSEMBLY - MATTE BLACK**



**SOLID (A)**

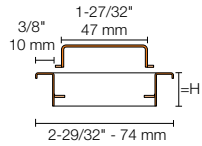

**SQUARE (B)**

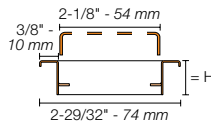

**Grate assemblies - Matte black**



3/4" (19 mm) frame height for  
1/8" to 9/16" (3 mm to 15 mm) -thick covering

Length = cm - in.	SOLID (A)	SQUARE (B)
	Item No.	Item No.
50 - <b>19-11/16</b>	KL1AR19MGS50	KL1B19MGS50
60 - <b>23-5/8</b>	KL1AR19MGS60	KL1B19MGS60
70 - <b>27-9/16</b>	KL1AR19MGS70	KL1B19MGS70
80 - <b>31-1/2</b>	KL1AR19MGS80	KL1B19MGS80
90 - <b>35-7/16</b>	KL1AR19MGS90	KL1B19MGS90
100 - <b>39-3/8</b>	KL1AR19MGS100	KL1B19MGS100
110 - <b>43-5/16</b>	KL1AR19MGS110	KL1B19MGS110
120 - <b>47-1/4</b>	KL1AR19MGS120	KL1B19MGS120



Schluter®-KERDI-LINE-STYLE

GRATE ASSEMBLY - BRUSHED STAINLESS STEEL STYLE DESIGNS



**CURVE**

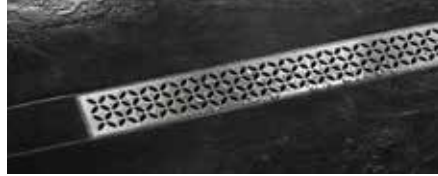
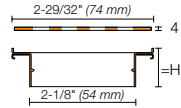

**FLORAL**

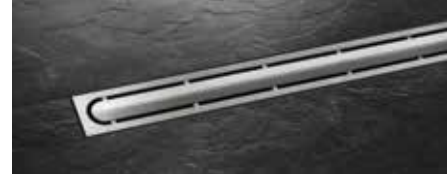
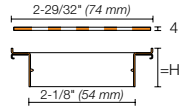

**PURE**

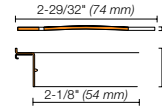

Grate assemblies - Brushed stainless steel



29/32" - 23 mm frame height for 1/4" - 11/16" (6 - 18 mm) -thick coverings

Length = in. - cm	CURVE <sup>1</sup>	FLORAL <sup>2</sup>	PURE <sup>3</sup>
	Item No.	Item No.	Item No.
19-11/16 - 50	KL1IFF 23 EB 50	KL1IFE 23 EB 50	KL1IFG 23 EB 50
23-5/8 - 60	KL1IFF 23 EB 60	KL1IFE 23 EB 60	KL1IFG 23 EB 60
27-9/16 - 70	KL1IFF 23 EB 70	KL1IFE 23 EB 70	KL1IFG 23 EB 70
31-1/2 - 80	KL1IFF 23 EB 80	KL1IFE 23 EB 80	KL1IFG 23 EB 80
35-7/16 - 90	KL1IFF 23 EB 90	KL1IFE 23 EB 90	KL1IFG 23 EB 90
39-3/8 - 100	KL1IFF 23 EB 100	KL1IFE 23 EB 100	KL1IFG 23 EB 100
43-5/16 - 110	KL1IFF 23 EB 110	KL1IFE 23 EB 110	KL1IFG 23 EB 110
47-1/4 - 120	KL1IFF 23 EB 120	KL1IFE 23 EB 120	KL1IFG 23 EB 120

1. U.S. Patent No. D831,168 2. U.S. Patent No. D831,170 3. U.S. Patent No. D831,169

Schluter®-KERDI-LINE

PERFORATED GRATE WITH LOCKING MECHANISM

The Schluter®-KERDI-LINE SQUARE grate assembly (B) with 3/4" (19 mm) frame height is available with a locking mechanism for applications where tamper resistance is required.



Length = in. - cm		Item No.
19-11/16	- 50	KL1BL 19 EB 50
23-5/8	- 60	KL1BL 19 EB 60
27-9/16	- 70	KL1BL 19 EB 70
31-1/2	- 80	KL1BL 19 EB 80
35-7/16	- 90	KL1BL 19 EB 90
39-3/8	- 100	KL1BL 19 EB 100
43-5/16	- 110	KL1BL 19 EB 110
47-1/4	- 120	KL1BL 19 EB 120
51-3/16	- 130	KL1BL 19 EB 130
55-1/8	- 140	KL1BL 19 EB 140
59-1/16	- 150	KL1BL 19 EB 150
62-15/16	- 160	KL1BL 19 EB 160
66-7/8	- 170	KL1BL 19 EB 170
70-13/16	- 180	KL1BL 19 EB 180

Note: Driver bit for tamper-proof screws sold separately. Please see page 23.

COVER PLATE

Schluter®-KERDI-LINE-FC

Schluter®-KERDI-LINE-FC is a stainless steel cover plate for use with the Schluter®-KERDI-LINE linear floor drain to create a seamless look in applications where multiple drains are installed end to end. KERDI-LINE-FC is designed for use with either the SOLID or SQUARE grates.

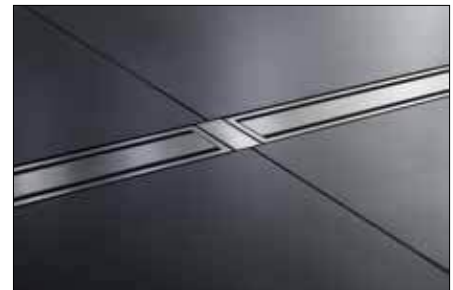
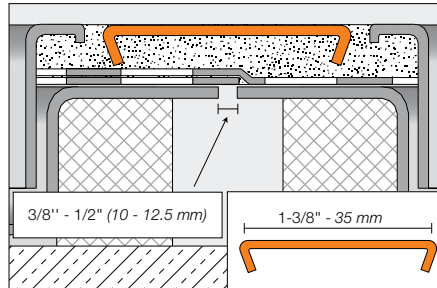
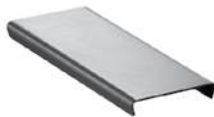

Schluter®-KERDI-LINE-FC Cover Plate		
Brushed stainless steel	Chrome	Matte black
Item No.	Item No.	Item No.
V / KLEB 35	V / KLEP 35	V / KLMGS 35

STRAINER

The Schluter®-KERDI-LINE Strainer is a hair catcher customized to fit inside the KERDI-LINE channel body to trap and collect hair. Simple to remove and clean, the hair catcher fits discreetly into the drain to prevent hair clogs that can lead to blocked pipes.



Strainer for KERDI-LINE	
Item No.	Description
KL VZ SF	Strainer



Schluter®-KERDI-LINE-VARIO

**GRATE ASSEMBLY - BRUSHED STAINLESS STEEL**



**HERRINGBONE**



**SLANT**



**SQUARE**



**FLORAL**

Grate assemblies - Brushed stainless steel			
HERRINGBONE	SLANT	SQUARE	FLORAL
Item No.	Item No.	Item No.	Item No.
Length = 122 cm - <b>48"</b>			
KL VRID 13 EB 122	KL VRID 14 EB 122	KL VRID 3 EB 122	KL VRID 5 EB 122
Length = 244 cm - <b>96"</b>			
KL VRID 13 EB 244	KL VRID 14 EB 244	KL VRID 3 EB 244	KL VRID 5 EB 244

Flange kit
Item No.
KL VR 2 FLK





**14.1 Schluter®-SHOWERPROFILE-SA** Two-part tapered edging profile

Item No.	H = in. - mm	H <sub>1</sub> = in. - mm	H <sub>2</sub> = in. - mm
L = 47-1/4" - 1.2 m			
SPSA 50 EB/120	3/16 - 5	1/4 - 6	1-3/16 - 30
L = 63" - 1.6 m			
SPSA 50 EB/160	3/16 - 5	1/4 - 6	1-1/2 - 38
L = 78-3/4" - 2 m			
SPSA 50 EB/200	3/16 - 5	1/4 - 6	1-13/16 - 46

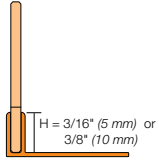

**14.1 Schluter®-SHOWERPROFILE-SB** Two-part tapered edging profile

Item No.	H = in. - mm	H <sub>1</sub> = in. - mm	H <sub>2</sub> = in. - mm
L = 47-1/4" - 1.2 m			
SPSB 100 EB/120	3/8 - 10	3/8 - 10	1-11/32 - 34
SPSB 125 EB/120	1/2 - 12.5	3/8 - 10	1-11/32 - 34
L = 63" - 1.6 m			
SPSB 100 EB/160	3/8 - 10	3/8 - 10	1-21/32 - 42
SPSB 125 EB/160	1/2 - 12.5	3/8 - 10	1-21/32 - 42
L = 78-3/4" - 2 m			
SPSB 100 EB/200	3/8 - 10	3/8 - 10	2 - 50
SPSB 125 EB/200	1/2 - 12.5	3/8 - 10	2 - 50



**Note:** Other sizes available. Contact Customer Service for price and availability.

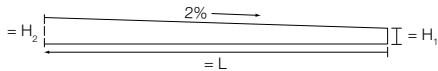

**14.1 Schluter®-SHOWERPROFILE-R** Two-part wall transition profile

Item No.	Height
L = 39" - 1 m	
SPRA 23 EB/100	29/32" - 1-3/8" (23 - 35 mm)
SPRA 33 EB/100	1-5/16" - 1-25/32" (33 - 45 mm)
L = 55" - 1.4 m	
SPRA 23 EB/140	29/32" - 1-3/8" (23 - 35 mm)
SPRA 33 EB/140	1-5/16" - 1-25/32" (33 - 45 mm)

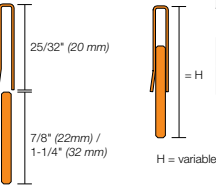

**Note:** When the SHOWERPROFILE-S/-R is not used with the Schluter®-Shower System the profile is covered under the Schluter®-Systems Wall and Countertop Profiles 5-Year Limited Warranty.

17.1 Schluter®-SHELF-E

Triangular corner shelf

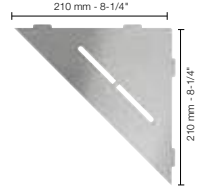
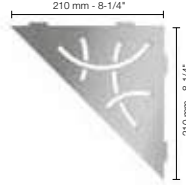
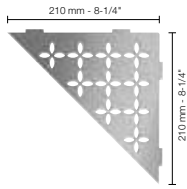

Schluter®-SHELF-E - FLORAL	
Item No.	Finish
SES1 D5 EB	Brushed stainless steel
SES1 D5 MBW	Matte white
SES1 D5 TSI	Ivory
SES1 D5 TSBG	Greige
SES1 D5 TSC	Cream
SES1 D5 TSOB	Bronze
SES1 D5 TSSG	Stone grey
SES1 D5 TSG	Pewter
SES1 D5 TSDA	Dark anthracite
SES1 D5 MGS	Matte black

Schluter®-SHELF-E - CURVE	
Item No.	Finish
SES1 D6 EB	Brushed stainless steel
SES1 D6 MBW	Matte white
SES1 D6 TSI	Ivory
SES1 D6 TSBG	Greige
SES1 D6 TSC	Cream
SES1 D6 TSOB	Bronze
SES1 D6 TSSG	Stone grey
SES1 D6 TSG	Pewter
SES1 D6 TSDA	Dark anthracite
SES1 D6 MGS	Matte black

Schluter®-SHELF-E - PURE	
Item No.	Finish
SES1 D7 EB	Brushed stainless steel
SES1 D7 MBW	Matte white
SES1 D7 TSI	Ivory
SES1 D7 TSBG	Greige
SES1 D7 TSC	Cream
SES1 D7 TSOB	Bronze
SES1 D7 TSSG	Stone grey
SES1 D7 TSG	Pewter
SES1 D7 TSDA	Dark anthracite
SES1 D7 MGS	Matte black

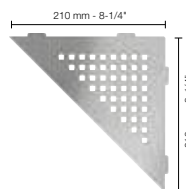
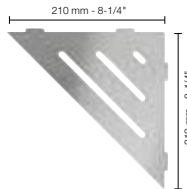

Schluter®-SHELF-E - WAVE	
Item No.	Finish
SES1 D10 EB	Brushed stainless steel
SES1 D10 MBW	Matte white
SES1 D10 TSI	Ivory
SES1 D10 TSBG	Greige
SES1 D10 TSC	Cream
SES1 D10 TSOB	Bronze
SES1 D10 TSSG	Stone grey
SES1 D10 TSG	Pewter
SES1 D10 TSDA	Dark anthracite
SES1 D10 MGS	Matte black

Schluter®-SHELF-E - SQUARE	
Item No.	Finish
SES1 D3 EB	Brushed stainless steel
SES1 D3 MBW	Matte white
SES1 D3 TSI	Ivory
SES1 D3 TSBG	Greige
SES1 D3 TSC	Cream
SES1 D3 TSOB	Bronze
SES1 D3 TSSG	Stone grey
SES1 D3 TSG	Pewter
SES1 D3 TSDA	Dark anthracite
SES1 D3 MGS	Matte black

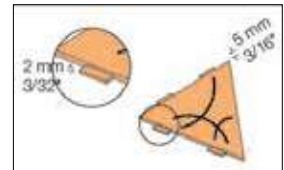

Stainless steel

Color-coated aluminum



17.1 Schluter®-SHELF-E

Pentagonal corner shelf

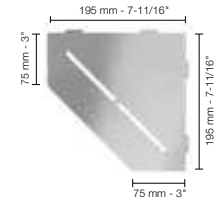
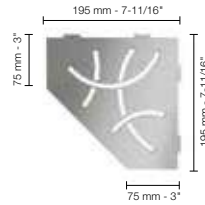
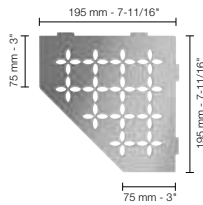

Schluter®-SHELF-E - FLORAL	
Item No.	Finish
SES2 D5 EB	Brushed stainless steel
SES2 D5 MBW	Matte white
SES2 D5 TSI	Ivory
SES2 D5 TSBG	Greige
SES2 D5 TSC	Cream
SES2 D5 TSOB	Bronze
SES2 D5 TSSG	Stone grey
SES2 D5 TSG	Pewter
SES2 D5 TSDA	Dark anthracite
SES2 D5 MGS	Matte black

Schluter®-SHELF-E - CURVE	
Item No.	Finish
SES2 D6 EB	Brushed stainless steel
SES2 D6 MBW	Matte white
SES2 D6 TSI	Ivory
SES2 D6 TSBG	Greige
SES2 D6 TSC	Cream
SES2 D6 TSOB	Bronze
SES2 D6 TSSG	Stone grey
SES2 D6 TSG	Pewter
SES2 D6 TSDA	Dark anthracite
SES2 D6 MGS	Matte black

Schluter®-SHELF-E - PURE	
Item No.	Finish
SES2 D7 EB	Brushed stainless steel
SES2 D7 MBW	Matte white
SES2 D7 TSI	Ivory
SES2 D7 TSBG	Greige
SES2 D7 TSC	Cream
SES2 D7 TSOB	Bronze
SES2 D7 TSSG	Stone grey
SES2 D7 TSG	Pewter
SES2 D7 TSDA	Dark anthracite
SES2 D7 MGS	Matte black

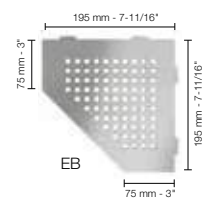
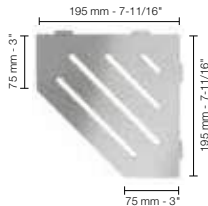

Schluter®-SHELF-E - WAVE	
Item No.	Finish
SES2 D10 EB	Brushed stainless steel
SES2 D10 MBW	Matte white
SES2 D10 TSI	Ivory
SES2 D10 TSBG	Greige
SES2 D10 TSC	Cream
SES2 D10 TSOB	Bronze
SES2 D10 TSSG	Stone grey
SES2 D10 TSG	Pewter
SES2 D10 TSDA	Dark anthracite
SES2 D10 MGS	Matte black

Schluter®-SHELF-E - SQUARE	
Item No.	Finish
SES2 D3 EB	Brushed stainless steel
SES2 D3 MBW	Matte white
SES2 D3 TSI	Ivory
SES2 D3 TSBG	Greige
SES2 D3 TSC	Cream
SES2 D3 TSOB	Bronze
SES2 D3 TSSG	Stone grey
SES2 D3 TSG	Pewter
SES2 D3 TSDA	Dark anthracite
SES2 D3 MGS	Matte black

Stainless steel

Color-coated aluminum



17.1 Schluter®-SHELF-E

Quadrilateral corner shelf

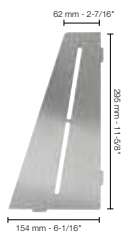
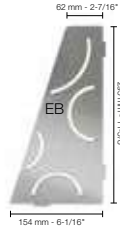
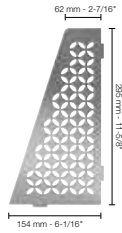

Schluter®-SHELF-E - FLORAL	
Item No.	Finish
SES3 D5 EB	Brushed stainless steel
SES3 D5 MBW	Matte white
SES3 D5 TSI	Ivory
SES3 D5 TSBG	Greige
SES3 D5 TSC	Cream
SES3 D5 TSOB	Bronze
SES3 D5 TSSG	Stone grey
SES3 D5 TSG	Pewter
SES3 D5 TSDA	Dark anthracite
SES3 D5 MGS	Matte black

Schluter®-SHELF-E - CURVE	
Item No.	Finish
SES3 D6 EB	Brushed stainless steel
SES3 D6 MBW	Matte white
SES3 D6 TSI	Ivory
SES3 D6 TSBG	Greige
SES3 D6 TSC	Cream
SES3 D6 TSOB	Bronze
SES3 D6 TSSG	Stone grey
SES3 D6 TSG	Pewter
SES3 D6 TSDA	Dark anthracite
SES3 D6 MGS	Matte black

Schluter®-SHELF-E - PURE	
Item No.	Finish
SES3 D7 EB	Brushed stainless steel
SES3 D7 MBW	Matte white
SES3 D7 TSI	Ivory
SES3 D7 TSBG	Greige
SES3 D7 TSC	Cream
SES3 D7 TSOB	Bronze
SES3 D7 TSSG	Stone grey
SES3 D7 TSG	Pewter
SES3 D7 TSDA	Dark anthracite
SES3 D7 MGS	Matte black

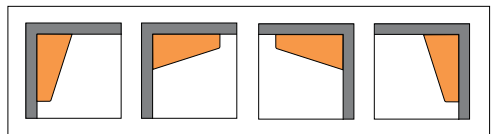
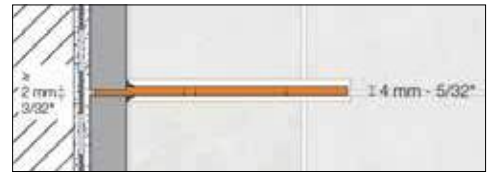
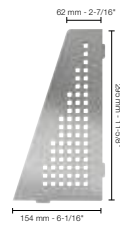

Schluter®-SHELF-E - WAVE	
Item No.	Finish
SES3 D10 EB	Brushed stainless steel
SES3 D10 MBW	Matte white
SES3 D10 TSI	Ivory
SES3 D10 TSBG	Greige
SES3 D10 TSC	Cream
SES3 D10 TSOB	Bronze
SES3 D10 TSSG	Stone grey
SES3 D10 TSG	Pewter
SES3 D10 TSDA	Dark anthracite
SES3 D10 MGS	Matte black

Schluter®-SHELF-E - SQUARE	
Item No.	Finish
SES3 D3 EB	Brushed stainless steel
SES3 D3 MBW	Matte white
SES3 D3 TSI	Ivory
SES3 D3 TSBG	Greige
SES3 D3 TSC	Cream
SES3 D3 TSOB	Bronze
SES3 D3 TSSG	Stone grey
SES3 D3 TSG	Pewter
SES3 D3 TSDA	Dark anthracite
SES3 D3 MGS	Matte black

Stainless steel

Color-coated aluminum



17.1 Schluter®-SHELF-N

Niche shelf

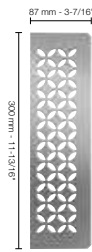

Schluter®-SHELF-N - FLORAL	
Item No.	Finish
SNS1 D5 EB	Brushed stainless steel
SNS1 D5 MBW	Matte white
SNS1 D5 TSI	Ivory
SNS1 D5 TSBG	Greige
SNS1 D5 TSC	Cream
SNS1 D5 TSOB	Bronze
SNS1 D5 TSSG	Stone grey
SNS1 D5 TSG	Pewter
SNS1 D5 TSDA	Dark anthracite
SNS1 D5 MGS	Matte black

Schluter®-SHELF-N - CURVE	
Item No.	Finish
SNS1 D6 EB	Brushed stainless steel
SNS1 D6 MBW	Matte white
SNS1 D6 TSI	Ivory
SNS1 D6 TSBG	Greige
SNS1 D6 TSC	Cream
SNS1 D6 TSOB	Bronze
SNS1 D6 TSSG	Stone grey
SNS1 D6 TSG	Pewter
SNS1 D6 TSDA	Dark anthracite
SNS1 D6 MGS	Matte black

Schluter®-SHELF-N - PURE	
Item No.	Finish
SNS1 D7 EB	Brushed stainless steel
SNS1 D7 MBW	Matte white
SNS1 D7 TSI	Ivory
SNS1 D7 TSBG	Greige
SNS1 D7 TSC	Cream
SNS1 D7 TSOB	Bronze
SNS1 D7 TSSG	Stone grey
SNS1 D7 TSG	Pewter
SNS1 D7 TSDA	Dark anthracite
SNS1 D7 MGS	Matte black

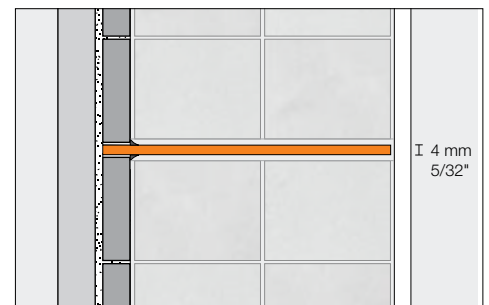
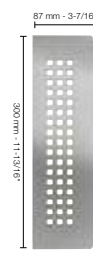
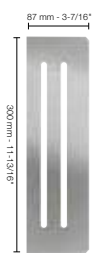

Schluter®-SHELF-N - WAVE	
Item No.	Finish
SNS1 D10 EB	Brushed stainless steel
SNS1 D10 MBW	Matte white
SNS1 D10 TSI	Ivory
SNS1 D10 TSBG	Greige
SNS1 D10 TSC	Cream
SNS1 D10 TSOB	Bronze
SNS1 D10 TSSG	Stone grey
SNS1 D10 TSG	Pewter
SNS1 D10 TSDA	Dark anthracite
SNS1 D10 MGS	Matte black

Schluter®-SHELF-N - SQUARE	
Item No.	Finish
SNS1 D3 EB	Brushed stainless steel
SNS1 D3 MBW	Matte white
SNS1 D3 TSI	Ivory
SNS1 D3 TSBG	Greige
SNS1 D3 TSC	Cream
SNS1 D3 TSOB	Bronze
SNS1 D3 TSSG	Stone grey
SNS1 D3 TSG	Pewter
SNS1 D3 TSDA	Dark anthracite
SNS1 D3 MGS	Matte black

Stainless steel

Color-coated aluminum





17.1 Schluter®-SHELF-W

Wall shelf

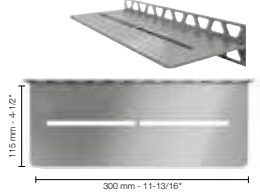
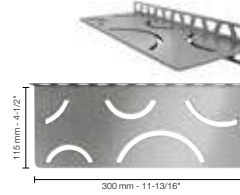
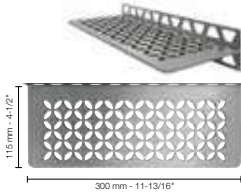

Schluter®-SHELF-W - FLORAL	
Item No.	Finish
SNS1 D5 EB	Brushed stainless steel
SNS1 D5 MBW	Matte white
SNS1 D5 TSI	Ivory
SNS1 D5 TSBG	Greige
SNS1 D5 TSC	Cream
SNS1 D5 TSOB	Bronze
SNS1 D5 TSSG	Stone grey
SNS1 D5 TSG	Pewter
SNS1 D5 TSDA	Dark anthracite
SNS1 D5 MGS	Matte black

Schluter®-SHELF-W - CURVE	
Item No.	Finish
SNS1 D6 EB	Brushed stainless steel
SNS1 D6 MBW	Matte white
SNS1 D6 TSI	Ivory
SNS1 D6 TSBG	Greige
SNS1 D6 TSC	Cream
SNS1 D6 TSOB	Bronze
SNS1 D6 TSSG	Stone grey
SNS1 D6 TSG	Pewter
SNS1 D6 TSDA	Dark anthracite
SNS1 D6 MGS	Matte black

Schluter®-SHELF-W - PURE	
Item No.	Finish
SNS1 D7 EB	Brushed stainless steel
SNS1 D7 MBW	Matte white
SNS1 D7 TSI	Ivory
SNS1 D7 TSBG	Greige
SNS1 D7 TSC	Cream
SNS1 D7 TSOB	Bronze
SNS1 D7 TSSG	Stone grey
SNS1 D7 TSG	Pewter
SNS1 D7 TSDA	Dark anthracite
SNS1 D7 MGS	Matte black

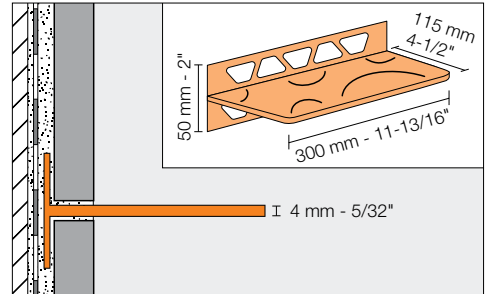
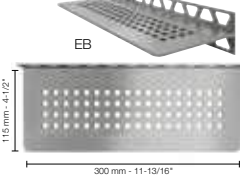
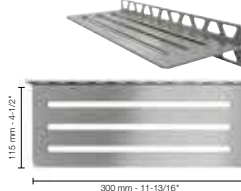

Schluter®-SHELF-W - WAVE	
Item No.	Finish
SWS1 D10 EB	Brushed stainless steel
SWS1 D10 MBW	Matte white
SWS1 D10 TSI	Ivory
SWS1 D10 TSBG	Greige
SWS1 D10 TSC	Cream
SWS1 D10 TSOB	Bronze
SWS1 D10 TSSG	Stone grey
SWS1 D10 TSG	Pewter
SWS1 D10 TSDA	Dark anthracite
SWS1 D10 MGS	Matte black

Schluter®-SHELF-W - SQUARE	
Item No.	Finish
SWS1 D3 EB	Brushed stainless steel
SWS1 D3 MBW	Matte white
SWS1 D3 TSI	Ivory
SWS1 D3 TSBG	Greige
SWS1 D3 TSC	Cream
SWS1 D3 TSOB	Bronze
SWS1 D3 TSSG	Stone grey
SWS1 D3 TSG	Pewter
SWS1 D3 TSDA	Dark anthracite
SWS1 D3 MGS	Matte black

Stainless steel

Color-coated aluminum



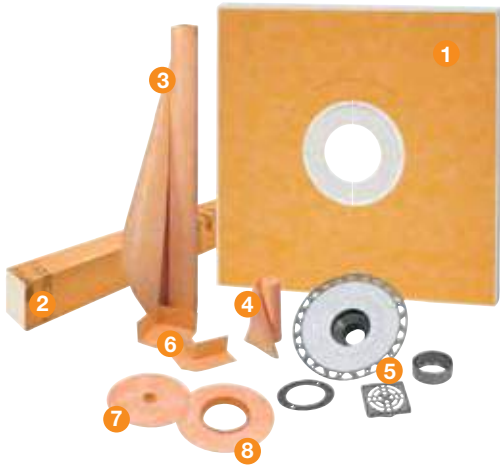
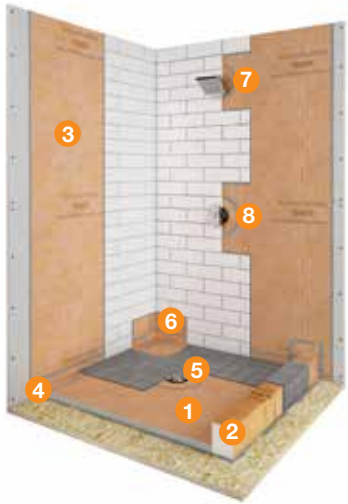

Schluter®-KERDI-SHOWER-KIT			
Includes	Description	Quantity	
		48" x 48"	38" x 60"
1 KERDI-SHOWER-T/-TS/-TT	Shower Tray	1	1
2 KERDI-BOARD-SC	Shower Curb 48" x 6" x 4-1/2"	1	
	KERDI-BOARD-SC		2
3 KERDI 10 M	Waterproofing membrane 3' 3" x 33' = <b>108 ft<sup>2</sup></b>	1	1
4 KERDI-BAND	Waterproofing strip 5" x 33'	1	1
5 KERDI-DRAIN	Flange with 2" (50 mm) outlet and stainless steel grate (E)	1	1
6 KERDI-KERECK-F	Preformed waterproofing corners	4 inside and 2 outside	
7 KERDI-SEAL-PS	Pipe seal (3/4" - 20 mm)	1	
8 KERDI-SEAL-MV	Mixing valve seal (4-1/4" - 114 mm)	1	

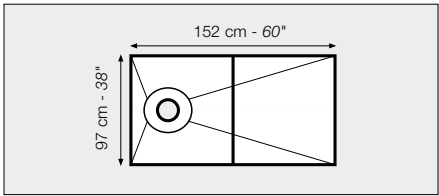
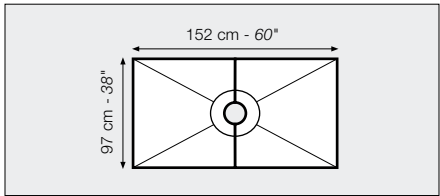
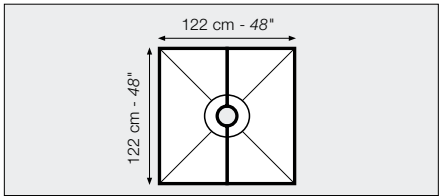

48" x 48" Kit - ABS or PVC			
Item No.	Drain Material	Grate finish	
KSK 1220 ABS E	ABS	E	
KSK 1220 PVC E	PVC	E	

38" x 60" Kit - ABS or PVC			
Item No.	Drain Material	Grate finish	
KSK 965 1525 ABS E	ABS	E	
KSK 965 1525 PVC E	PVC	E	

38" x 60" Kit off-center - ABS or PVC			
Item No.	Drain Material	Grate finish	
KSK 965 1525S ABSE	ABS	E	
KSK 965 1525S PVCE	PVC	E	

**Note:** Tray features off-center drain placement: 10" (25.4 cm) o.c. from end of tray.

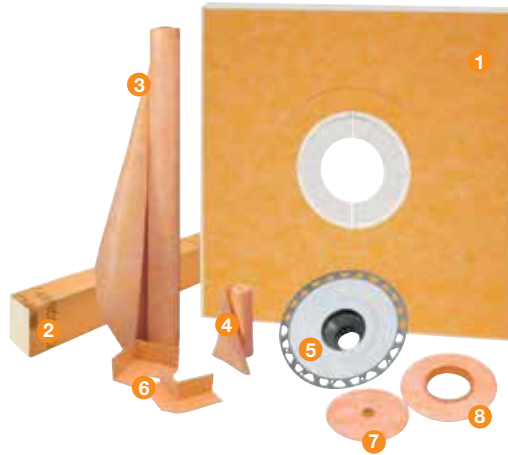
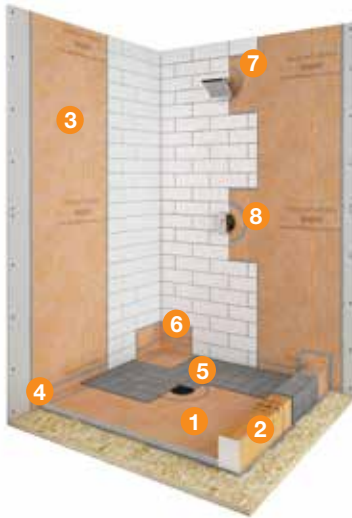

**Schluter®-KERDI-SHOWER-KIT - WITHOUT THE GRATE**

Includes	Description	Quantity			
		48" x 48"	38" x 60"	48" x 72"	72" x 72"
1 KERDI-SHOWER-T/-TS/-TT	Shower Tray	1	1	1	1
2 KERDI-BOARD-SC	Shower Curb 48" x 6" x 4-1/2"	1			
KERDI-BOARD-SC	Shower Curb 38" x 6" x 4-1/2"		2	2	2
3 KERDI 5 M	Waterproofing membrane 3' 3" x 16' 5" = <b>54 ft<sup>2</sup></b>				1
KERDI 10 M	Waterproofing membrane 3' 3" x 33' = <b>108 ft<sup>2</sup></b>	1	1		1
KERDI 12 M	Waterproofing membrane 3' 3" x 39' 4" = <b>128 ft<sup>2</sup></b>			1	
4 KERDI-BAND	Waterproofing strip 5" x 33'	1	1	2	2
5 KERDI-DRAIN Flange	Flange with 2" (50 mm) outlet	1	1	1	1
6 KERDI-KERECK-F	Preformed waterproofing corners	4 inside and 2 outside			
7 KERDI-SEAL-PS	Pipe seal (3/4" - 20 mm)	1			
8 KERDI-SEAL-MV	Mixing valve seal (4-1/2" - 114 mm)	1			

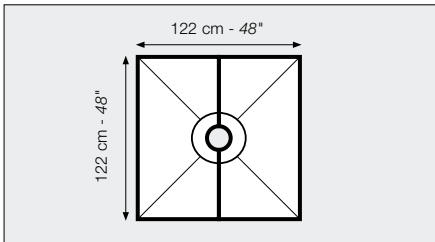

48" x 48" Kit - ABS or PVC	
Item No.	Drain Material
KSK 1220 ABS	ABS
KSK 1220 PVC	PVC

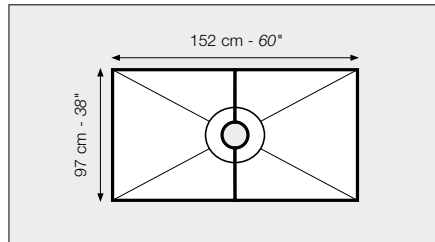

38" x 60" Kit - ABS or PVC	
Item No.	Drain Material
KSK 965 1525 ABS	ABS
KSK 965 1525 PVC	PVC

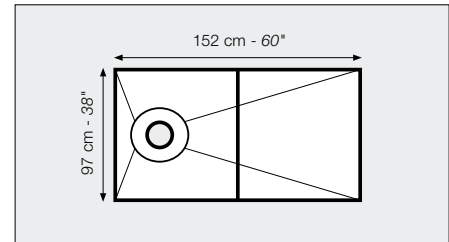

38" x 60" Kit off-center - ABS or PVC	
Item No.	Drain Material
KSK 965 1525S ABS	ABS
KSK 965 1525S PVC	PVC

**Note:** Tray features off-center drain placement: 10" (25.4 cm) o.c. from end of tray.

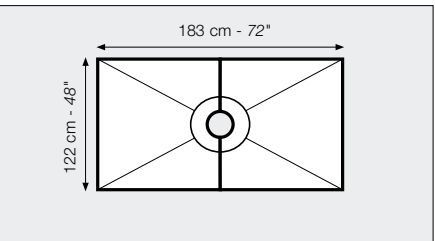

48" x 72" Kit - ABS or PVC	
Item No.	Drain Material
KSK 1220 1830 ABS	ABS
KSK 1220 1830 PVC	PVC

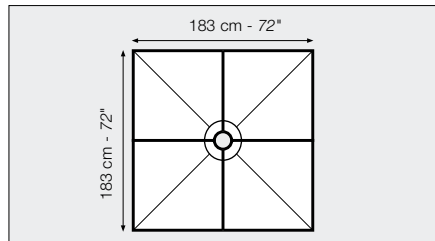

72" x 72" Kit - ABS or PVC	
Item No.	Drain Material
KSK 1830 ABS	ABS
KSK 1830 PVC	PVC

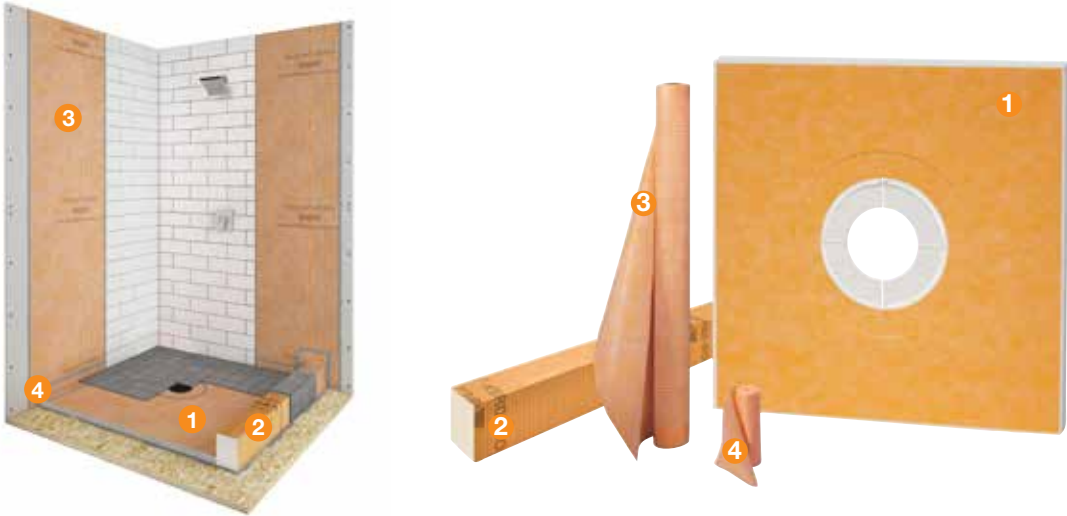

**Schluter®-KERDI-SHOWER-KIT - WITHOUT THE DRAIN**

Includes	Description	Quantity			
		48" x 48"	38" x 60"	48" x 72"	72" x 72"
1 KERDI-SHOWER-T/-TS/-TT	Shower Tray	1	1	1	1
2 KERDI-BOARD-SC	Shower Curb 48" x 6" x 4-1/2"	1			
	KERDI-BOARD-SC		2	2	2
3 KERDI 5 M	Waterproofing membrane 3' 3" x 16' 5" = <b>54 ft<sup>2</sup></b>				1
	KERDI 10 M	1	1		1
	KERDI 12 M			1	
4 KERDI-BAND	Waterproofing strip 5" x 33'	1	1	2	2

Tray size	Item No.
48" x 48"	KSK 1220
38" x 60"	KSK 965 1525
38" x 60" off-center drain	KSK 965 1525S
48" x 72"	KSK 1220 1830
72" x 72"	KSK 1830



Schluter®-KERDI-TUBKIT			
Item No.	Includes	Description	Quantity
KKB7	1 KERDI 7M	Waterproofing membrane 3' 3" x 23' = 75 ft <sup>2</sup>	1
	2 KERDI-BAND	Waterproofing strip 5" x 16' 5"	1
	3 KERDI-SEAL-PS	Pipe seal 3/4"	1
	4 KERDI-SEAL-MV	Mixing valve seal 4-1/2"	1
	5 KERDI-FIX	Sealing and bonding compound, bright white	1

Product Listings and Certifications Table

Schluter®-KERDI-DRAIN - Listings and Certifications

Grates Flanges	Grate - 4" (100 mm)					Grate - 6" (150 mm)		
	CLASSIC Stainless steel (All finishes except EOB)	CLASSIC Stainless steel EOB	CONTOUR Anodized aluminum (All finishes)	Tileable	STYLE - PURE, CURVE and FLORAL Stainless steel (All finishes)	Stainless steel		
						CLASSIC 6E	CLASSIC ROUND 6RE	Cover 6CE
2" PVC	1	-	1	1	1	1	2	
2" ABS	1	-	1	1	1	1	2	
2" PVC Horizontal	1	-	1	1	1	1	2	
2" ABS Horizontal	1	-	1	1	1	1	2	
2" Stainless steel	1	-	1	1	1	1	2	
2" Stainless steel Threaded	1	-	1	1	1	1	2	
3" PVC	-	-	-	-	-	1	1	2
3" ABS	-	-	-	-	-	1	1	2
3" Stainless steel	-	-	-	-	-	1	1	2
5-1/4" Adaptor	-	-	-	-	-	-	-	-
7-1/2" Adaptor	-	-	-	-	-	-	-	-

Schluter®-KERDI-LINE

Bonding Flange	Grate					
	A	B	D	FLORAL (E)*	CURVE (F)*	PURE (G)*
Center outlet - 19-11/16" - 47-1/4" (50 cm - 120 cm)	1	1	1	1	1	1
Center outlet - 51-3/16" - 70-13/16" (130 cm - 180 cm)	1	1	1	1	1	1
Off-set outlet - 27-9/16" - 47-1/4" (70 cm - 120 cm)	1	1	1	1	1	1

Various configurations of KERDI-DRAIN and KERDI-LINE are listed by ICC-ES (Report No. PMG-1204), UPC®, and CSA as shown in the table above.

1 - Listed by ICC-ES (Report No. PMG-1204), UPC®, and CSA.

2 - Listed by CSA

For copies of these documents, please contact Schluter®-Systems at 800-472-4588 (USA) or 800-667-8746 (Canada) or by email at info@schluter.com. Links to the documents can also be accessed at www.schluter.com.



## Schluter®-Shower System 10-Year Limited Warranty

**LIMITED WARRANTY COVERAGE:** Subject to the conditions and limitations as stated in this **Schluter®-Shower System 10-Year Limited Warranty** (the “**Limited Warranty**”), Schluter Systems warrants that its Schluter®-Shower System (the “**Products**”) will be free from manufacturing defects and will perform as described in the Schluter®-Shower System Installation Handbook and Schluter® Waterproofing Membranes Technical Data Sheet (collectively, the “**Written Materials**”) for a period of ten (10) years from the date of purchase when installed and used in accordance with the terms and conditions of the Written Materials and industry standard guidelines that are not in conflict with the Written Materials in effect at the time of installation.

For the purposes of this Limited Warranty, “**Products**” are defined to include, as applicable in the original installation: Schluter®-KERDI-SHOWER prefabricated shower trays, Schluter®-KERDI-DS waterproofing membranes, Schluter®-KERDI-BOARD waterproof building panels, Schluter®-KERDI-BAND waterproofing strips, Schluter®-KERDI-DRAIN, Schluter®-KERDI-DRAIN-H, Schluter®-KERDI-LINE, and Schluter®-LINE-VARIO drains, Schluter®-KERDI-BOARD-SC shower curb, Schluter®-KERDI-BOARD-SB shower bench, Schluter®-KERDI-SHOWER-R shower ramp, Schluter®-KERDI-BOARD-SN and Schluter®-KERDI-BOARD-SNLT shower niches, Schluter®-KERDI-KERECK-F waterproofing corners, Schluter®-KERDI-KERS waterproofing corners, Schluter®-KERDI-KM, Schluter®-DILEX profiles, Schluter®-SHOWERPROFILES, Schluter®-KERDI-LINE-FC cover plate, Schluter®-SHELF shower shelves, Schluter®-KERDI-SEAL-PS/-MV seals, and/or Schluter®-KERDI-FIX adhesive/sealant; “**Owner**” is defined as the original end user of the property in which the Products are installed; and “**Tile Assembly**” is defined to include the Products, non-reusable tile surfaces, and applicable setting and grouting materials.

This Limited Warranty is only applicable to installations in the United States of America and Canada. Schluter Systems is not responsible or liable under any circumstances for determining the suitability of the Products for the Owner's intended purpose. It is the responsibility of the Owner to consult with an experienced and professional installer to ensure the suitability of the Products, subfloor/substrate and all building materials in the installation and that the Written Materials are followed properly.

**RESOLUTION:** If the Products are installed and used in accordance with the terms and conditions as described hereinabove and such Products are proven defective within the applicable warranty term, the Owner's exclusive remedy and the sole obligation of Schluter Systems, at its election, shall be to (a) reinstall or replace the failed portion of the Tile Assembly or (b) pay an amount not to exceed the original square foot cost of the installation of the Tile Assembly verified to be defective. Due to conditions beyond the control of Schluter Systems (e.g., color and shade availability, discontinuation, normal wear and tear), Schluter Systems cannot guarantee or warrant an exact match to the specific tile, stone, or other tiling materials used in the original installation. In such event, substantially similar materials may be substituted.

**EXCLUSIONS FROM COVERAGE:** This Limited Warranty excludes and in no event shall Schluter Systems have any liability for any indirect, special, incidental, punitive, exemplary, or consequential damages, including lost profits, arising out of or otherwise connected to the failure of the Products or Tile Assembly, regardless of any strict liability or active or passive negligence of Schluter Systems, and regardless of legal theory, whether in contract, tort, extra-contractual or other. This Limited Warranty further excludes any loss or damage arising out of or otherwise connected to: acts of war, terrorism, fire, explosion, natural disaster, acts of God, any failure to comply with the Written Materials, inadequate subfloor/substrate, improper preparation or other failure of subfloor/substrate, faulty or negligent penetration of the Products or subfloor/substrate, intentional acts of destruction, structural failure, misuse of or failure to maintain the Products, normal wear and tear, scratches, dents, corrosion or discoloration (whether caused by excessive heat, chemical cleaning products, abrasive agents or otherwise), efflorescence and shading which are a natural occurrence with cementitious materials and are not considered a defective condition for the purposes of this Limited Warranty, variations of texture, color or shade from those on product samples, packaging materials or other marketing materials, or other causes unrelated to the Products (e.g. surface covering failure, excess point loading, overvoltage). This Limited Warranty excludes exterior applications and applications utilizing non-approved surface coverings, unless specifically approved in writing on a case by case basis by the Schluter Systems Technical Services Director.

This Limited Warranty is conditioned and will be considered null and void and Schluter Systems will have the right to refuse any claims if: (a) the Products have been improperly stored or installed, (b) any non-Schluter Systems product is substituted for a Schluter Systems component in a Schluter®-Shower System, or (c) the Products are subject to abusive or abnormal use, lack of maintenance, or used in a manner other than that for which the Products were designed or in any way contrary to the Written Materials

**DISCLAIMER:** There are no warranties beyond this expressed warranty as stated herein. To the extent permitted by law, all other warranties, representations or conditions, expressed or implied, are hereby disclaimed and excluded, including but not limited to the implied warranties of **MERCHANTABILITY** or **FITNESS FOR A PARTICULAR PURPOSE** (as limited to such purposes as described in the Written Materials) or arising from a course of dealing, usage of trade or otherwise by law. ANY IMPLIED WARRANTIES ARISING BY OPERATION OF LAW ARE LIMITED IN DURATION TO THE TERM OF THIS LIMITED WARRANTY. NO REPRESENTATION, PROMISE, AFFIRMATION OR STATEMENT BY ANY EMPLOYEE OR AGENT OF SCHLUTER SYSTEMS WILL BE ENFORCEABLE AGAINST SCHLUTER SYSTEMS UNLESS IT IS SPECIFICALLY INCLUDED IN THIS LIMITED WARRANTY OR AUTHORIZED IN WRITING BY THE SCHLUTER SYSTEMS TECHNICAL SERVICES DIRECTOR. This Limited Warranty is given in lieu of any other warranty, whether expressed or implied. The remedies contained herein are the only remedies available for breach of this Limited Warranty. This Limited Warranty extends only to the Owner and is not transferable or assignable unless authorized by written agreement and signed by the Schluter Systems Technical Services Director or otherwise prohibited by specific state or provincial law. This Limited Warranty gives you specific legal rights; some states and provinces do not allow disclaimers or other restrictions of implied warranties; some of the above disclaimers may not apply to you. **No changes or modifications of any terms or conditions of this Limited Warranty are permitted unless duly authorized in writing by the Schluter Systems Technical Services Director.** This Limited Warranty shall supersede and replace any and all prior oral or written warranties, agreements, or other representations made by or on behalf of Schluter Systems relative to the Products or the application of the Products and shall apply to any installation occurring on or after June 15, 2023. If the Schluter®-Shower System is used in conjunction with other Schluter products, a different Schluter warranty may apply. For the most current information and materials regarding Schluter Systems warranties and programs, please visit [https://www.schluter.com/schluter-us/en\\_US/downloadfiles](https://www.schluter.com/schluter-us/en_US/downloadfiles).

**MAKING A CLAIM:** To make a claim under this Limited Warranty, the Owner must provide Schluter Systems<sup>2</sup> with written notice within thirty (30) days of any alleged defect in the Products covered by this Limited Warranty, together with date and proof of purchase of such Products and/or all of its components and name and address of all installers and all invoices related to the original installation, failing which this Limited Warranty shall have no legal effect<sup>3</sup>. Schluter Systems reserves the right at its election and as a condition of this Limited Warranty to inspect the alleged failed and/or defective Products.

### All U.S. Claims must be sent to:

Schluter Systems L.P.  
Attn: Warranty Claims Dept.  
194 Pleasant Ridge Road  
Plattsburgh, NY 12901-5841

### All Canadian Claims must be sent to:

Schluter Systems (Canada), Inc.  
Attn: Warranty Claims Dept.  
21100 chemin Ste-Marie  
Ste-Anne-de-Bellevue, QC H9X 3Y8

<sup>1</sup>If there are any conflicting terms between any Written Materials, the most recently updated document shall be deemed to control.

<sup>2</sup>This Limited Warranty is limited to sales of the Products made in and intended for use in the United States and Canada. For the purposes of this Limited Warranty, Schluter Systems L.P. shall offer warranty coverage to Owners located in the United States, and Schluter Systems (Canada) Inc. shall offer coverage to Owners located in Canada.

<sup>3</sup>In the event that Owner fails to provide such required invoices relating to the original installation, Schluter Systems shall pay Owner an amount equal to the average, reasonable costs of a comparable installation. If the parties fail to agree on such amount, such dispute shall promptly, and in the first instance, be submitted: (a) if a U.S. claim, to arbitration in Clinton County, New York, in accordance with the rules of the American Arbitration Association, or (b) if a Canadian claim, in the Province of Quebec, Canada, in accordance with the ADRIC Arbitration Rules. Any outcome of such arbitration proceeding shall be final and binding upon the parties hereto.

# Schluter®-Systems Lifetime Thin-Set System Extended Limited Warranty

**LIMITED WARRANTY COVERAGE:** Subject to the conditions and limitations as stated in this **Lifetime Thin-Set System Extended Limited Warranty** (the "**Limited Warranty**"), Schluter Systems warrants that a Thin-Set System (defined hereafter) will be free from manufacturing defects and will perform as described in the applicable installation handbook(s) and/or technical data sheet(s) (collectively, the "**Written Materials**") for the lifetime (defined hereafter) of such Thin-Set System when installed in a Residential or Commercial application (defined hereafter) and used in accordance with the terms and conditions of the Written Materials and industry standard guidelines that are not in conflict with the Written Materials in effect at the time of installation. In order to extend warranty coverage for Schluter® DITRA® or DITRA®-XL uncoupling membranes, Schluter®-Shower System, Schluter® KERDI® or KERDI®-DS waterproofing membranes, or Schluter® DITRA-HEAT™ or Schluter® DITRA-HEAT-DUO™ uncoupling membrane to lifetime coverage under this Lifetime Thin-Set System Extended Limited Warranty, Owner must complete and submit the Thin-Set System Registration to Schluter Systems, available at [www.schluter.com](http://www.schluter.com), or submit proof of purchase and installation information (including installation date, installer's name and address) to Schluter Systems at the address provided hereafter within ninety (90) days of installation.

For the purposes of this Limited Warranty, a "**Thin-Set System**" is defined as Schluter® DITRA® or DITRA®-XL uncoupling membranes, Schluter®-Shower System, Schluter®-KERDI®-BOARD within a Schluter®-Shower System, Schluter® KERDI® or KERDI®-DS waterproofing membranes, or Schluter® DITRA-HEAT™ or Schluter® DITRA-HEAT-DUO™ uncoupling membrane installed with Schluter SET®, Schluter ALL-SET®, or Schluter FAST-SET® thin-set mortar; "**Owner**" is defined as the original end user of the property in which a Thin-Set System is installed; "**Lifetime**" is defined as that period of time that the original Thin-Set System installation remains unchanged and under the ownership of the Owner; "**Residential**" applications are defined to include Thin-Set System installations in single family detached residential dwellings; and "**Commercial**" applications are defined to include Thin-Set System installations in multi-family residential dwellings (e.g., apartments, condominiums, cooperatives, and timeshares). Thin-Set System installations in public places, commercial establishments and other applications may be afforded lifetime coverage under this Limited Warranty on a case by case basis as determined by the Schluter Systems Technical Services Director.

This Limited Warranty is only applicable to installations in the United States of America and Canada. Schluter Systems is not responsible or liable under any circumstances for determining the suitability of a Thin-Set System for the Owner's intended purpose. It is the responsibility of the Owner to consult with an experienced and professional installer to ensure the suitability of a Thin-Set System, subfloor/substrate and all building materials in the installation and that the Written Materials are followed properly.

**RESOLUTION:** If a Thin-Set System is installed and used in accordance with the terms and conditions as described hereinabove and such Thin-Set System is proven defective within the applicable warranty term, the Owner's exclusive remedy and the sole obligation of Schluter Systems, at its election, shall be to (a) reinstall or replace the failed portion of the Thin-Set System or (b) pay an amount not to exceed the original square foot cost of the installation of the Thin-Set System verified to be defective. Due to conditions beyond the control of Schluter Systems (e.g., color and shade availability, discontinuation, normal wear and tear), Schluter Systems cannot guarantee or warrant an exact match to the specific tile, stone, or other flooring materials used in the original installation. In such event, substantially similar materials may be substituted.

**EXCLUSIONS FROM COVERAGE:** This Limited Warranty excludes and in no event shall Schluter Systems have any liability for any indirect, special, incidental, punitive, exemplary, or consequential damages, including lost profits, arising out of or otherwise connected to the failure of a Thin-Set System, regardless of any strict liability or active or passive negligence of Schluter Systems, and regardless of legal theory, whether in contract, tort, extra-contractual or other. This Limited Warranty further excludes any loss or damage arising out of or otherwise connected to: acts of war, terrorism, fire, explosion, natural disaster, acts of God, any failure to comply with the Written Materials, inadequate subfloor/substrate, improper preparation or other failure of subfloor/substrate, faulty or negligent penetration of a Thin-Set System or subfloor/substrate, intentional acts of destruction, structural failure, misuse of or failure to maintain a Thin-Set System, normal wear and tear, scratches, dents, corrosion or discoloration (whether caused by excessive heat, chemical cleaning products, abrasive agents or otherwise), efflorescence and shading which are a natural occurrence with cementitious materials and are not considered a defective condition for the purposes of this Limited Warranty, variations of texture, color or shade from those on product samples, packaging materials or other marketing materials, or other causes unrelated to a Thin-Set System (e.g. excess point loading, overvoltage). This Limited Warranty excludes exterior, submerged and steam room applications and further excludes applications using glass tile, resin-backed tile, and/or moisture sensitive stone unless specifically approved in writing on a case by case basis by the Schluter Systems Technical Services Director. Schluter® DITRA-HEAT™-E-HK heating cables and Schluter® DITRA-HEAT™-E thermostats are specifically excluded from coverage under this Limited Warranty. Any substitution of a non-Schluter Systems product for a Schluter Systems component in a Thin-Set System voids this Limited Warranty.

**DISCLAIMER:** There are no warranties beyond this expressed warranty as stated herein. To the extent permitted by law, all other warranties, representations or conditions, expressed or implied, are hereby disclaimed and excluded, including but not limited to the implied warranties of **MERCHANTABILITY** or **FITNESS FOR A PARTICULAR PURPOSE** (as limited to such purposes as described in the Written Materials) or arising from a course of dealing, usage of trade or otherwise by law. ANY IMPLIED WARRANTIES ARISING BY OPERATION OF LAW ARE LIMITED IN DURATION TO THE TERM OF THIS LIMITED WARRANTY. NO REPRESENTATION, PROMISE, AFFIRMATION OR STATEMENT BY ANY EMPLOYEE OR AGENT OF SCHLUTER SYSTEMS WILL BE ENFORCEABLE AGAINST SCHLUTER SYSTEMS UNLESS IT IS SPECIFICALLY INCLUDED IN THIS LIMITED WARRANTY OR AUTHORIZED IN WRITING BY THE SCHLUTER SYSTEMS TECHNICAL SERVICES DIRECTOR. This Limited Warranty is given in lieu of any other warranty, whether expressed or implied. The remedies contained herein are the only remedies available for breach of this Limited Warranty. Schluter Systems excludes and in no event shall have any liability for any indirect, special, incidental, punitive, exemplary, or consequential damages, including lost profits, arising out of or otherwise connected to failure of a Thin-Set System. This Limited Warranty extends only to the Owner and is not transferable or assignable unless authorized by written agreement and signed by the Schluter Systems Technical Services Director or otherwise prohibited by specific state or provincial law. This Limited Warranty gives you specific legal rights; some states and provinces do not allow disclaimers or other restrictions of implied warranties; some of the above disclaimers may not apply to you. **No changes or modifications of any terms or conditions of this Limited Warranty are permitted unless duly authorized in writing by the Schluter Systems Technical Services Director.** This Limited Warranty shall supersede and replace any and all prior oral or written warranties, agreements, or other representations made by or on behalf of Schluter Systems relative to a Thin-Set System or the application of a Thin-Set System and shall apply to any installation occurring on or after March 13, 2017. For the most current information and materials regarding Schluter Systems warranties and programs, please visit [https://www.schluter.com/schluter-us/en\\_US/downloadfiles](https://www.schluter.com/schluter-us/en_US/downloadfiles).

**MAKING A CLAIM:** To make a claim under this Limited Warranty, the Owner must provide Schluter Systems with written notice within thirty (30) days of any alleged defect in a Thin-Set System covered by this Limited Warranty, together with date and proof of purchase of such Thin-Set System and/or all of its components and name and address of all installers and all invoices related to the original installation, failing which this Limited Warranty shall have no legal effect. Schluter Systems reserves the right at its election and as a condition of this Limited Warranty to inspect the alleged failed and/or defective Thin-Set System.

## All U.S. Claims shall be sent to:

Schluter Systems L.P.  
Attn: Warranty Claims Dept.  
194 Pleasant Ridge Road  
Plattsburgh, NY 12901-5841

## All Canadian Claims shall be sent to:

Schluter Systems (Canada), Inc.  
Attn: Warranty Claims Dept.  
21100 chemin Ste-Marie  
Ste-Anne-de-Bellevue, QC H9X 3Y8

<sup>1</sup>If there are any conflicting terms between any Written Materials, the most recently updated document shall be deemed to control.

<sup>2</sup>In the event that Owner fails to provide such required invoices relating to the original installation, Schluter Systems shall pay Owner an amount equal to the average, reasonable costs of a comparable installation. If the parties fail to agree on such amount, such dispute shall promptly, and in the first instance, be submitted: (a) if a U.S. claim, to arbitration in Clinton County, New York, in accordance with the rules of the American Arbitration Association, or (b) if a Canadian claim, in the Province of Quebec, Canada, in accordance with the ADRIC Arbitration Rules. Any outcome of such arbitration proceeding shall be final and binding upon the parties hereto.



Schluter Systems L.P. 📍 194 Pleasant Ridge Rd. | Plattsburgh, NY | 12901-5841 ☎ 800-472-4588 📠 800-477-9783

Schluter Systems (Canada) Inc. 📍 21100 chemin Ste-Marie | Ste-Anne-de-Bellevue, QC | H9X 3Y8 ☎ 800-667-8746 📠 877-667-2410

🌐 [schluter.com](http://schluter.com)

This technical data sheet is subject to change without notice. Please visit [Schluter.com](http://Schluter.com) for the latest version.